

HAWK ENTERPRISES

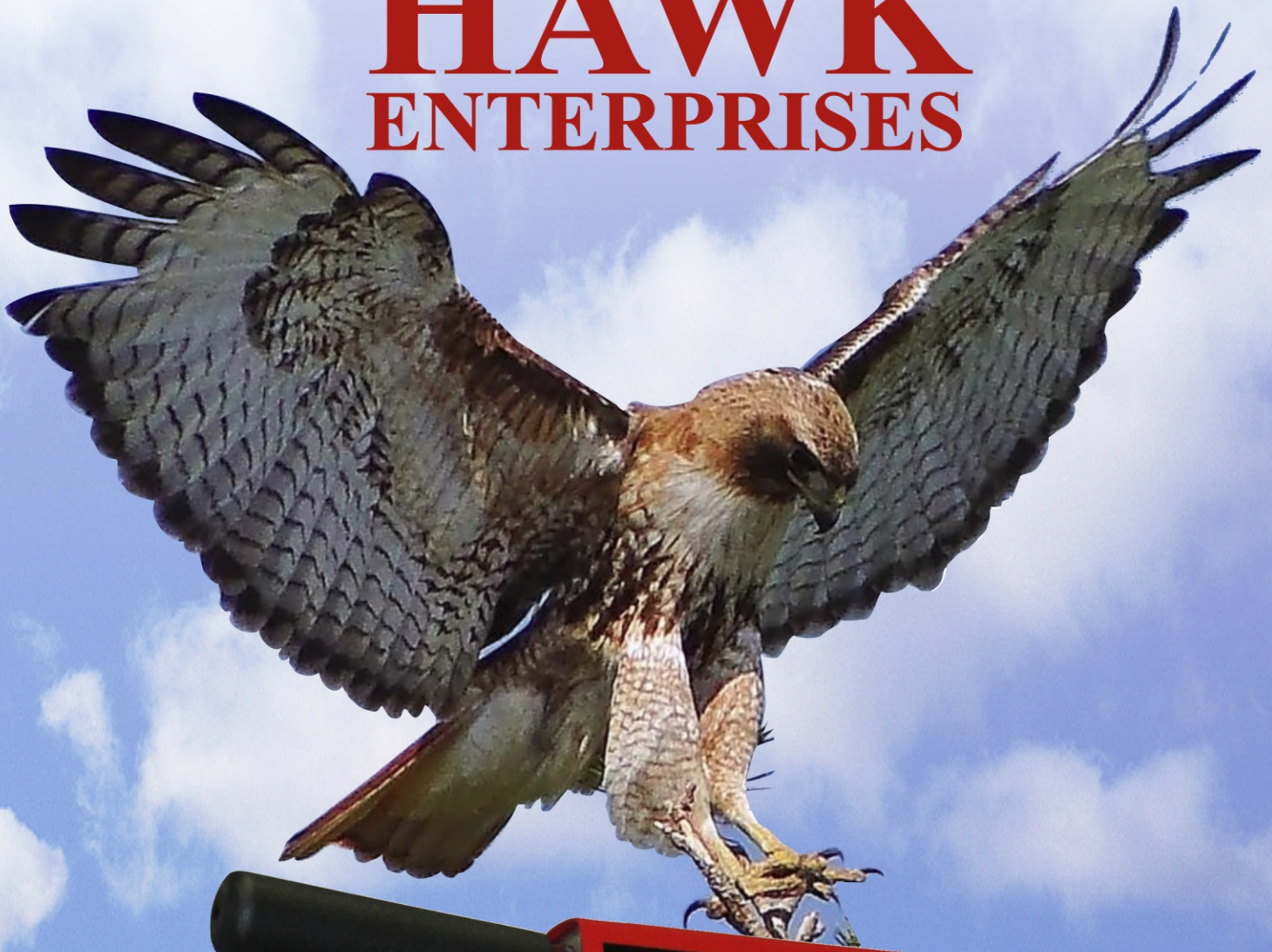

Rotary Floor Machines • Orbital Floor Machines

Burnishers • Cleaning Equipment

HAWK ENTERPRISES • 2902 Park Six Court, Elkhart, IN 46514

(574) 294-1910 • (888) 289-4295

www.hawkenterprises.com

9/2018



Your Reliable Source



Hawk has been designing and building high quality floor machines and specialty equipment in Elkhart, IN since 1995.

Hawk is an innovator in development of orbital floor machine technology. We currently offer five platforms of orbital equipment, making Hawk a leader in the industry.

Breakthrough technology continues with our exclusive "Floating Head" WD™ detachable handle machines. The results are substantial improvements in productivity and user safety. WD™ handles are now available on both rotary and orbital floor machines.

When it comes to custom design and private branding, look no further. No other machine manufacturer offers more choices, lower minimums or greater value than Hawk Enterprises.

Discover the Hawk Line

Floor Machines

Hawk Mighty	4
Hawk HD	5
Hawk XHD	6
Hawk 2-Speed	7
Hawk XHD 2-Speed	8
Brute Severe Duty	9
Hawk TEXHD	10
Hawk Pro	11

Floating Head Floor Machines

Glide Freedom.....	12
Glide Freedom 2-Speed.....	13
Merlin TEXHD.....	14
Merlin 2-Speed XHD	15

Orbital Floor Machines

Hawk G2 Raptor	16
TigerHawk 1410	17
TigerHawk 2014	18
TigerHawk 2814	19
RedTail 2014-180.....	20

High Speed Burnishers

Hawk High-Speed	21
Hawk High-Speed AC	22
Hawk Centerfold High Speed	23

Black Hawk Machines

BlackHawk FM Rotary Floor Machines.....	24
BlackHawk 1250 High Speed Burnisher.....	25
BlackHawk 1500 High Speed Burnisher.....	26

Air Movers

BVP25 Air Mover	27
BVP50 Air Mover	28
BPB25DA Axial Air Mover.....	29
BH25AD Axial Air Mover.....	30
Industrial Air Mover	31

Vacuums

Hawk 20 and 55 Gallon Wet/Dry Tank Vacuum.....	32
Hawk Harrier Backpack Vacuum.....	33

Specialty Equipment

Hawk Propane Burnisher.....	34
Hot Shot Mini-Vactor Carpet Extractor.....	35
Hawk Talon Edger Floor Machine.....	36

Accessories

Rotary Floor Machine Accessories.....	37
Rotary Floor Brushes, Pads and Pad Drivers.....	38
TigerHawk Orbital Floor Machine Accessories.....	39
Burnisher Accessories.....	40
Private Label Program	41





Hawk Mighty
 Small Area Stripping,
 Scrubbing, Polishing
 165 RPM, 13", 15"



Hawk HD
 Stripping, Scrubbing,
 Carpet Care
 175 RPM,
 13", 15", 17", 20"



Hawk XHD
 Xtra Duty Stripping,
 Scrubbing, Carpet Care
 165 RPM,
 13", 15", 17", 20"

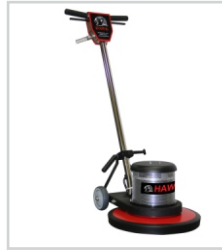

Hawk 2-Speed
 Stripping, Buffing,
 Carpet Care
 175/320 RPM,
 13", 15", 17", 20"

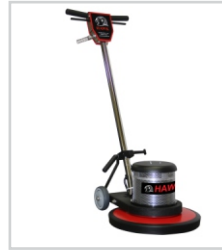

Hawk XHD 2-Speed
 Stripping, Buffing,
 Carpet Care
 165/300 RPM,
 13", 15", 17", 20"



Hawk Brute
 Deluxe Severe Duty
 Stripping, Sanding,
 Resurfacing, Carpet Care
 165 RPM
 15", 17", 20"



Hawk TEXHD
 Severe Duty
 Stripping, Sanding,
 Resurfacing, Carpet Care
 165 RPM
 13", 15", 17", 20"



Hawk Pro
 Professional Floor
 Restoration Machine
 165 RPM,
 17", 20"



Hawk Glide Freedom
 WD™ Floor Machines
 Floor & Carpet Care
 175 RPM - Standard,
 165 RPM - XHD
 13", 15", 17", 20"



Hawk Glide Freedom
Dual-Speed
 WD™ Floor Machines
 Floor & Carpet Care
 175-320 RPM - Std.
 165-320 RPM - XHD
 13", 15", 17", 20"



Hawk Merlin
 Severe Duty
 WD™ Floor Machines
 165 RPM
 17", 20"



Hawk Merlin Dual-Speed
 Severe Duty
 WD™ Floor Machines
 165-300 RPM
 17", 20"



Hawk G2 Raptor
 Orbital Floor Machine
 Scrubbing, Wet/Dry
 Stripping
 1740 RPM - 20"x14"



Hawk 1410
 Small Area Orbital
 Floor Machine
 1725 RPM
 14"x10"



Hawk 2014
 Deluxe Orbital
 Floor Machine
 1740 RPM
 20"x14"



Hawk 2814
 Wide Area Orbital
 Floor Machine
 1740 RPM
 28"x14"



Hawk RedTail 2014-180
 Surface Prep
 Orbital Floor Machine
 1740 RPM
 20"x14"



Hawk High Speed
 DC 1500, 1800, 2000 RPM
 13", 15", 17", 20"
 AC 1000, 1500 RPM
 13", 15", 17"



Hawk High Speed
Centerfold Burnishers
 DC Motor
 1500, 1800, 2000 RPM
 13", 15", 17", 20"



BlackHawk FM Buffer
 Stripping, Buffing,
 Carpet Care
 175 RPM,
 17", 20"



BlackHawk 1500 Burnisher
 DC Motor
 1500 RPM - 20"
BlackHawk 1250 Burnisher
 AC Motor
 1250 RPM - 20"



Stripping, Scrubbing, Polishing

Machine operators will appreciate the performance, versatility and value in the Hawk Mighty. The 1.0 HP TEFC AC motor and XHD gears deliver huge power in a small and manageable machine. It's ideal for use in tight spaces, restrooms, edging and stairs.

The TH models, with telescoping handle, fit every operator's height and store in tight spaces.

Power

- 1.0 HP, 56 frame, dual capacitor, AC motor
- 115-230V , 50/60 Hz
- 50 ft. 14-3 SJT power cord with molded plug

Drive System

- Triple-planetary Severe-Duty 11:1 helical-cut industrial gears, case hardened with steel coupler
- Gears drive brushes and pads at 165 RPM

Engineered Design

- All steel construction with welded, powder-coated frame
- Telescoping handle (TH models) adjusts from 36" to 48"
- 13" and 15" steel brush covers with full wraparound bumper
- One piece powder-coated, heavy duty steel handle with 6-position pin lock
- Comfortable vinyl handle grips
- Thumb-operated safety switch. Negative pressure on/off switch.
- Dual steel operating triggers
- 1"x5" non-marking ball bearing wheels

Safety Features

- Quiet 64 dB operation. Meets GS42 standard.
- Built with UL Listed components



ELKHART, IN



Specifications

Model	MIGHTY13	MIGHTY 13-TH	MIGHTY15	MIGHTY15-TH
Part #	F0060-13	F0060-13TH	F0060-15	F0060-15TH
Size	13"	13"	15"	15"
Pad Size	12"	12"	14"	14"
Telescoping Handle	No	Yes	No	Yes
Pad Speed	165 RPM	165 RPM	165 RPM	165 RPM
Amp Draw	4.9 Amp	4.9 Amp	6 Amp	6 Amp
Weight	87 lbs.	87 lbs.	90 lbs.	90 lbs.

All Models

Motor	1.0 HP, 56 frame, dual capacitor AC motor
Power Source	115-230V, 50/60 Hz
Power Cord	50 ft. 14-3 SJT power cord w/molded plug
Driver System	Triple-planetary XHD 11:1 helical-cut industrial gears
dB Rating	64 dB - Meets GS42 standard

Subject to Change Without Notice

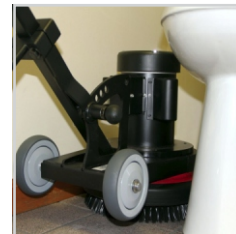

Works in Tight Spaces



Telescoping Handle Adjusts from 36" to 48"



Optional 2.5-Gallon Solution Tank

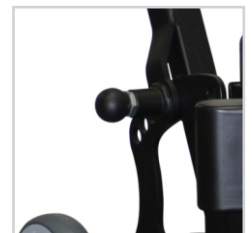

Handle with 6-Position Pin Lock



Stripping, Scrubbing, Carpet Care

Realize maximum power with the twin capacitor, AC motor and Hawk's ruggedly reliable floor machine design. Machine operators appreciate the solid performance of an extremely well-built floor machine that delivers reliability on every job.

Power

- 1.5 HP, 66 frame, dual capacitor AC motor
- 115-230V, 60 Hz
- 50 ft. 14-3 STO industrial power cord with molded plug

Drive System

- Triple-planetary HD 10:1 helical-cut commercial gears drive pads and brushes at 175 RPM

Engineered Design

- All steel construction with welded, powder-coated frame
- One piece chrome, heavy-duty steel handle with vinyl grips
- Variable position positive handle lock
- 13", 15", 17" and 20" steel brush covers with full wraparound bumper
- Private branding - 7 color plus chrome brush covers
- Dual steel operating triggers
- Negative pressure on/off switch
- Thumb-operated safety switch
- 1" x 5" non-marking ball bearing wheels
- The addition of weights can stress equipment components. Adding weights to non XHD models is not recommended.

Safety Features

- Quiet 60 dB operation. Meets GS42 standard.
- UL/CUL listed



Specifications

Model #	HP1515-HD	HP1517-HD	HP1520-HD
Part #	F0006	F0009	F0012
Machine Size	15 inch	17 inch	20 inch
Pad Size	14 inch	16 inch	19 inch
Pad Speed	175 RPM	175 RPM	175 RPM
Current Draw	5.7 Amp	5.9 Amp	6.5 Amp
Machine Wt.	91 lbs.	94 lbs.	97 lbs.

All Sizes

Motor	1.5 HP, 66 frame, dual capacitor AC motor
Power	115-230V, 60 Hz
Power Cord	50 ft. 14-3 STO industrial power cord w/molded plug
Drive System	Triple-planetary HD 10:1 helical-cut commercial gears
dB Rating	60 dB - Meets GS42 standard

Subject to Change Without Notice



HDX Model Includes Chrome Motor, Splash Guard & Pad Driver



Optional 4 Gallon Solution Tank
5 Stock Colors



Welded Steel Frame and Handle



7 Stock Colors Plus Chrome



HAWK XHD

Xtra Duty Floor Machine

Stripping, Scrubbing, Carpet Care

When the job gets tough, the tough get going with the HAWK XHD. The heavy-duty machine is powered by the 1.5 HP dual capacitor motor combined with a super-strong XHD 11:1 gearbox. Offered with a wide range of tools, accessories and optional weights, the XHD handles every job.

Power

- 1.5 HP, 66 frame, dual capacitor AC motor
- 115-230V, 60 Hz
- 50 ft. 14-3 STO industrial power cord with molded plug

Drive System

- Triple-planetary XHD 11:1 helical-cut industrial gears, case hardened with steel coupler
- Gears drive brushes and pads at 165 RPM

Engineered Design

- All steel construction with welded, powder-coated frame
- One piece chrome, heavy-duty steel handle with variable position lock and vinyl grips
- 13", 15", 17" and 20" steel brush covers with full wraparound bumper
- Private branding - 7 color plus chrome brush covers
- Dual steel operating triggers
- Negative pressure on/off switch
- Thumb-operated safety switch
- 1" x 5" non-marking ball bearing wheels

Safety Features

- Quiet 66 dB operation. Meets GS42 standard.
- UL/CUL listed



Specifications

Model #	HP1513-XHD	HP1515-XHD	HP1517-XHD	HP1520-XHD
Part #	F0013XHD	F0006XHD	F0009XHD	F0012XHD
Machine Size	13 inch	15 inch	17 inch	20 inch
Pad Size	12 inch	14 inch	16 inch	19 inch
Pad Speed	165 rpm	165 rpm	165 rpm	165 rpm
Amp Draw	5.3 Amp	5.6 Amp	6.1 Amp	6.8 Amp

All Sizes	
Motor	1.5 HP, 66 frame dual capacitor AC motor
Power	115-230V, 60 Hz
Power Cord	50 ft. 14-3 STO industrial power cord w/molded plug
Drive System	Triple-planetary XHD 11:1 helical-cut industrial gears
dB Rating	66 dB - Meets GS42 standard

Subject to Change Without Notice



Welded Steel Frame, Handle & Brush Covers



Optional 4 Gallon Solution Tank
5 Stock Colors



Optional Splash Guards



7 Stock Colors Plus Chrome



Stripping, Buffing, Carpet Care

The Hawk 2-Speed floor machine performs heavy-duty scrubbing and stripping at the standard 175 RPM speed. With the flip of the conveniently located toggle switch, buff and polish at 320 RPM.

Power

- 1.5 HP, 66 frame, DC rectified 2-speed motor
- 115V, 50/60 Hz (230V optional)
- 50 ft. 14-3 STO industrial power cord with molded plug
- Change speed with Hi-Lo speed control switch on handle

Drive System

- Triple-planetary HD 10:1 helical-cut commercial gears drive pads/brushes at 175 or 320 RPM

Engineered Design

- All steel construction with welded, powder-coated frame
- One piece chrome, heavy-duty steel handle with variable position lock and vinyl grips
- 13", 15", 17" and 20" steel brush covers with full wraparound bumper
- Private branding - 7 color plus chrome brush covers
- Dual steel operating triggers
- Negative pressure on/off switch
- Thumb-operated safety switch
- 1" x 5" non-marking ball bearing wheels
- The addition of weights can stress equipment components. Adding weights to non XHD models is not recommended.

Safety Features

- Quiet operation – 62 dB (low speed), 69 dB (high speed). Meets GS42 standard.
- UL/CUL listed



ELKHART, IN



Specifications

Model #	HP1513-2S	HP1515-2S	HP1517-2S	HP1520-2S
Part #	F0003-13	F0003-15	F0003-17	F0003-20
Machine Size	13 inch	15 inch	17 inch	20 inch
Pad Size	12 inch	14 inch	16 inch	19 inch
Pad Speed RPM	175/320 rpm	175/320 rpm	175/320 rpm	175/320 rpm
Amp Draw	7.8/8.2 Amp	8.1/8.5 Amp	8.5/9.1 Amp	9.2/9.5 Amp

All Sizes	
Motor	1.5 HP, 66 frame, DC rectified 2-speed motor
Power	115V, 50/60 Hz (230V optional)
Power Cord	50 ft. 14-3 STO industrial power cord w/molded plug
Drive System	Triple-planetary HD 10:1 helical-cut commercial gears
dB Rating	62dB (175 RPM) - 69dB (320 RPM) - Meets GS42 standard



Hi/Lo Speed Motor Switch on Handle



Optional 4 Gallon Solution Tank
5 Stock Colors

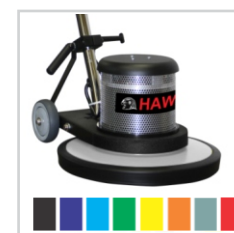

7 Stock Colors Plus Chrome



1.5 HP Power to Drive the Range of Brushes

Subject to Change Without Notice



Xtra Duty Dual-Speed Floor Machine

Stripping, Buffing, Carpet Care



The Hawk 2-Speed XHD strips and scrubs at 165 RPM. With a flip of the switch, polish the floor at 300 RPM. This heavy-duty machine is powered by the 1.5 HP, rectified, 2-speed DC motor with an industrial XHD 11:1 gearbox.

Power

- 1.5 HP, 66 frame, DC rectified 2-speed motor
- 115V, 50/60 Hz (230V optional)
- 50 ft. 12-3 SJTOW industrial power cord with molded plug
- Change speed with Hi-Lo speed control switch on the handle

Drive System

- Triple-planetary XHD 11:1 helical-cut industrial gears, case hardened with steel coupler
- Gears drive brushes and pads at 165 or 300 RPM

Engineered Design

- All steel construction with welded, powder-coated frame
- One piece chrome, heavy-duty steel handle with variable position lock and vinyl grips
- Variable position positive handle lock
- 13", 15", 17" and 20" steel brush covers with full wraparound bumper
- Private branding - 7 color plus chrome brush covers
- Dual steel operating triggers
- Negative pressure on/off switch
- Thumb-operated safety switch
- 1" x 5" non-marking ball bearing wheels

Safety Features

- Quiet operation – 66 dB (low speed), 72 dB (high speed). Meets GS42 standard.
- UL/CUL listed



Specifications				
Model #	HP1513-2S-XHD	HP1515-2S-XHD	HP1517-2S-XHD	HP1520-2S-XHD
Part #	F0003-13XHD	F0003-15XHD	F0003-17XHD	F0003-20XHD
Machine Size	13 inch	15 inch	17 inch	20 inch
Pad Size	12 inch	14 inch	16 inch	19 inch
Pad Speed	165/300 rpm	165/300 rpm	165/300 rpm	165/300 rpm
Amp Draw	5.3 /6.3 Amp	5.6/6.6 Amp	6.1/6.8 Amp	6.8/7.2 Amp
All Sizes				
Motor	1.5 HP, 66 frame, DC rectified 2-speed motor			
Power	115V, 50/60 Hz (230V optional)			
Power Cord	50 ft. 12-3 SJTOW industrial power cord w/molded plug			
Drive System	Triple-planetary XHD 11:1 helical-cut industrial gears			
dB Rating	66dB (165 RPM) - 72dB (300 RPM) - Meets GS42 standard			



Handle Mounted 2-Speed Switch



Optional 4 Gallon Solution Tank - 5 Stock Colors 4 Special Order Colors

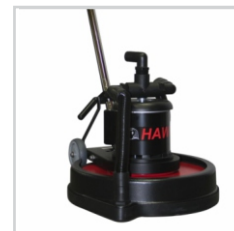

Optional Dust Control 17" & 20" Stand Kit



7 Stock Colors Plus Chrome

Subject to Change Without Notice



Deluxe Severe Duty Floor Machine

Stripping, Sanding, Carpet Care, Resurfacing



The Brute is built with severe-duty gear drive, a steel coupler and the 180-frame TEFC chrome motor.

Use the Brute in the harshest conditions - dust, moisture, chemicals, and for sanding, screening, stone and concrete work.

Power

- 1.5 HP, 180 frame, TEFC dual capacitor AC motor
- 115-230V, 60 Hz (50 Hz optional)
- 50 ft. 12-3 SJTOW industrial power cord with molded plug

Drive System

- Triple-planetary XHD 11:1 helical-cut industrial gears, case-hardened with steel coupler
- Gears drives brushes and pads at 165 RPM

Engineered Design

- All steel construction with welded, powder-coated frame
- One piece chrome, heavy-duty steel handle with variable position handle lock and vinyl grips
- Deluxe chrome finish
- 15", 17" and 20" steel brush covers with full wraparound bumper
- Private branding - 7 color plus chrome brush covers
- Dual steel operating triggers
- Negative pressure on/off switch.
- Thumb-operated safety switch
- 1" x 5" non-marking ball bearing wheels
- Optional mounted weights provide extra down pressure for fastest results

Safety Features

- Quiet 66 dB operation. Meets GS42 standard.
- UL/CUL listed



Specifications

Model #	HP1515-180BRUTE	HP1517-180BRUTE	HP1520-180BRUTE
Part #	F0006-180CP	F0009-180CP	F0012-180CP
Machine Size	15 inch	17 inch	20 inch
Pad Size	14 inch	16 inch	19 inch
Pad Speed	165 RPM	165 RPM	165 RPM
Amp Draw	7.5 Amp	7.9 Amp	8.4 Amp

All Sizes	
Motor	1.5 HP, 180 frame, TEFC dual capacitor AC motor
Power	115-230V, 60 Hz (50 Hz optional)
Power Cord	50 ft. 12-3 SJTOW industrial power cord w/molded plug
Drive System	Triple-planetary XHD 11:1 helical-cut industrial gears
dB Rating	66 dB - Meets GS42 standard



Add the 25 lb. Custom "U" Weights for Fast Results (not to exceed 75 lbs)



Optional 4 Gallon Solution Tank - 5 Stock Colors 4 Special Order Colors



Optional Dust Pickup System Vacuum Connection



1.5 HP, 180 Frame Motor Drives Powerful Tools

Subject to Change Without Notice



Stripping, Sanding, Carpet Care, Resurfacing

The TEXHD is built with the severe duty helical-cut gear drive, steel coupler, and a 180 frame TEFC black motor.

Use the TEXHD in the harshest conditions - dust, moisture, chemicals, and for sanding, screening, stone, and concrete work.

Power

- 1.5 HP, 180 frame, TEFC dual capacitor AC motor
- 115-230V, 60 Hz (50 Hz optional)
- 50 ft. 12-3 SJTOW industrial power cord with molded plug

Drive System

- Triple-planetary XHD 11:1 helical-cut industrial gears, case hardened with steel coupler
- Gears drive brushes and pads at 165 RPM

Engineered Design

- All steel construction with welded, powder-coated frame
- One piece chrome, heavy-duty steel handle with variable position lock and vinyl grips
- 13", 15", 17" and 20" steel brush covers with full wraparound bumper
- Private branding - 7 color plus chrome brush covers
- Dual steel operating triggers
- Negative pressure on/off switch
- Thumb-operated safety switch
- 1" x 5" non-marking ball bearing wheels
- Optional 4 gallon solution tank

Safety Features

- Quiet 66 dB operation. Meets GS42 standard.
- UL/CUL listed



Specifications

Model #	HP1513-180TEXHD	HP1515-180TEXHD	HP1517-180TEXHD	HP1520-180TEXHD
Part Number	F0013-180	F0006-180	F0009-180	F0012-180
Machine Size	13 inch	15 inch	17 inch	20 inch
Pad Size	12 inch	14 inch	16 inch	19 inch
Pad Speed	165 RPM	165 RPM	165 RPM	165 RPM
Amp Draw	7.2 Amp	7.5 Amp	7.9 Amp	8.4 Amp

All Sizes

Motor	1.5 HP, 180 frame, TEFC dual capacitor AC motor
Power	115-230V, 60 Hz (50 Hz optional)
Power Cord	50 ft. 12-3 SJTOW industrial power cord w/molded plug
Drive System	Triple-planetary XHD 11:1 helical-cut industrial gears
dB Rating	66 dB - Meets GS42 standard

Subject to Change Without Notice



Dust Pickup System with Vacuum Connection Option

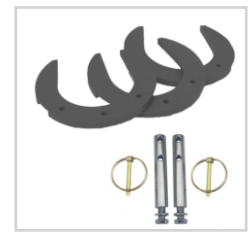

Add the 25 lb. Custom "U" Weights for Fast Results (not to exceed 75 lbs)



7 Private Brand Colors Plus Chrome



Power for Optional Grinder and Scraper Tools



Professional Floor Restoration Machine

Stripping, Scrubbing, Resurfacing



The HAWK Pro is designed for the professional in mind. This severe duty machine handles the range of tasks with the 180-frame TEFC motor with hardened steel gears that drive scrapers, sanders and tools at 165 RPM.

The Pro includes two removable 25 lb. weights mounted on the brush cover, a convenient upper handle lock, 3" wider handle, a no-spill solution tank, pad driver and splash guard.

Power

- 1.5 HP, 180 frame, TEFC dual capacitor AC motor
- 115-230V, 60 Hz (50 Hz optional)
- 50 ft. 2-pc. 12-3 SJTOW industrial power cord

Drive System

- Triple-planetary XHD 11:1 helical-cut industrial gears, case hardened with steel coupler
- Gears drive brushes and pads at 165 RPM

Engineered Design

- All steel construction with welded, powder-coated frame
- One piece chrome, heavy-duty steel handle with variable position lock and vinyl grips
- Ergonomic upper handle lock handle is 3" wider for leverage
- 13", 15", 17" and 20" steel brush covers with full wraparound bumper
- Private branding - 7 color plus chrome brush covers
- Dual steel operating triggers. Thumb operated safety switch.
- Negative pressure on/off switch
- 1" x 5" non-marking ball bearing wheels
- Includes premium pad driver, 4.5 gal. solution tank, splash guard
- Includes removable 50# weight set with mounting lock pins for extra down pressure and faster results

Safety Features

- Quiet 66 dB operation. Meets GS42 standard.
- UL/CUL listed



ELKHART, IN



Specifications

Model #	HP1513-180PRO	HP1515-180PRO	HP1517-180PRO	HP1520-180PRO
Part Number	F0013-180PRO	F0006-180PRO	F0009-180PRO	F0012-180PRO
Machine Size	13 inch	15 inch	17 inch	20 inch
Pad Size	12 inch	14 inch	16 inch	19 inch
Pad Speed	165 RPM	165 RPM	165 RPM	165 RPM
Amp Draw	7.2 Amp	7.5 Amp	7.9 Amp	8.4 Amp

All Sizes

Motor	1.5 HP, 180 frame, TEFC dual capacitor AC motor
Power	115-230V, 60 Hz (50 Hz optional)
Power Cord	50 ft. 2-pc. 12-3 SJTOW industrial power cord w/molded plug
Drive System	Triple-planetary XHD 11:1 helical-cut industrial gears
dB Rating	66 dB - Meets GS42 standard

Subject to Change Without Notice



Power for Optional Grinder and Scraper Tools



Includes Pad Driver & Splash Guard



Optional Dust Control System



Upper Handle Lock is Easy to Access



Stripping, Scrubbing, Carpet Maintenance



The Hawk Glide delivers up to twice the performance, superior safety and draws 1/3 less amps than traditional floor machines. Our unique “Floating Head” handle carriage design provides 100% contact with the floor and steers the Glide in forward-and-backward movement - unlike the side-to-side movements of traditional rotary machines. Easy to learn. Easy to use.

Power

- 1.5 HP, 66 frame, dual capacitor AC motor
- 115-230V, 60 Hz
- 50 ft. 14-3 SJT (Glide) or 12-3 SJTOW (Glide XHD) power cord with molded plug

Drive System

- **Glide** uses triple-planetary HD 10:1 helical-cut commercial gears. Drives brushes and pads at 175 RPM.
- **Glide XHD** (Extra Heavy Duty) uses triple-planetary XHD 11:1 helical-cut industrial gears, case hardened with steel coupler. Drives brushes and pads at 165 RPM.

Engineered Design

- Exclusive WD™ Wheels Down detachable handle carriage design produces 100% flat contact with the floor
- All steel construction with welded frame. Heavy-duty powder coated steel handle with 5-position pin lock and vinyl grips.
- 17" and 20" steel brush covers with full wraparound bumper
- Dual steel operating triggers. Thumb-operated safety switch.
- 2" x 6" non-marking ball bearing wheels
- Optional 4 gallon solution tank - black and natural colors
- Optional splash guard and dust collection kit

Safety Features

- Quiet 66 dB operation. Meets GS42 standard.
- Built with UL approved components



ELKHART, IN



Specifications

Model	GLIDE 17	GLIDE 17XHD	GLIDE 20	GLIDE 20XHD
Part #	F0091-17	F0091-17XHD	F0091-20	F0091-20XHD
Machine Size	17"	17"	20"	20"
Pad Size	16"	16"	19"	19"
Rotary Brush Size	15"	15"	18"	18"
Pad Speed	175 RPM	165 RPM	175 RPM	165 RPM
Gear Box	10:1	11:1	10:1	11:1
Amp Draw	6.7 Amp	7.1 Amp	6.9 Amp	7.3 Amp

All Models

Motor	1.5 HP, 66 frame dual capacitor AC motor
Power	115-230V, 60 Hz
Power Cord	50 ft. 14-3 SJT (Glide) or 12-3 SJTOW (Glide XHD)
dB Rating	66 dB - Meets GS42 standard



Optional Dust Control Ring
Connects to Tank Vacuum



Optional
4 Gallon Solution Tank



Glide XHD Has Chromed
Motor w/ 11:1 Gear Box



5-Position Pin Lock Handle
All Steel Construction



HAWK Glide Freedom 2-Speed Dual-Speed WD™ Floor Machine

Stripping, Scrubbing, Carpet Maintenance



The Hawk Glide 2-Speed delivers twice the performance and superior safety over traditional floor machines. Our unique “Floating Head” handle carriage design provides 100% contact with the floor and steers the Glide in forward-and-backward movement, unlike the side-to-side movements of traditional rotary machines. Scrub at 165 or 175 RPM. Polish at 300 or 320 RPM.

Power

- 1.5 HP, 66 frame, rectified 2-speed DC motor
- 115V, 50/60 Hz (230V optional)
- 50 ft. 14-3 SJT (Glide 2-Speed) or 12-3 SJTOW (Glide 2-Speed XHD) power cord with molded plug
- Hi/Low speed switch is located on the motor

Drive System

- **Glide 2-Speed** uses triple-planetary HD 10:1 helical-cut commercial gears to drive pads at 175 or 320 RPM
- **Glide 2-Speed XHD** uses triple-planetary XHD 11:1 helical-cut industrial gears with case hardened with steel coupler to drive pads at 165 or 300 RPM

Engineered Design

- Exclusive WD™ detachable handle carriage design
- All steel construction with welded frame
- Heavy-duty powder coated steel handle with 5-position pin lock and vinyl grips
- 17" and 20" steel brush covers with full wraparound bumper
- 2"x 6" non-marking ball bearing wheels
- Optional 4 gallon solution tank

Safety Features

- Quiet 62 dB (low speed), 69 dB (high speed) operation. Meets GS42 standard.
- Built with UL Listed components



ELKHART, IN



Specifications

Model	GLIDE 17-2S	GLIDE 17-2SXHD	GLIDE 20-2S	GLIDE 20-2SXHD
Part #	F0091-17-2S	F0091-17-2SXHD	F0091-20-2S	F0091-20-2SXHD
Gear Box	10:1	11:1	10:1	11:1
Machine Size	17"	17"	20"	20"
Pad Size	16"	16"	19"	19"
Pad Speed	175/320 RPM	165/300 RPM	175/320 RPM	165/300 RPM
Amp Draw	8.5/9.1 Amp	8.5/9.1 Amp	9.2/9.6 Amp	9.2/9.6 Amp
Power Cord	50', 14-3 SJT	50' 12-3 SJTOW	50' 14-3 SJT	50', 12-3 SJTOW

All Models

Motor	66 frame, 1.5 HP rectified 2-speed DC motor
Power	115V, 50/60 Hz (230V optional)
dB Rating	62 dB (low speed) - 69 dB (high speed) Meets GS42 Std.

Subject to Change Without Notice



Optional
4 Gallon Solution Tank



Optional Dust Control Ring
Connects to Tank Vacuum



2-Speed Motor Switch
on Motor



5-Position Pin Lock Handle
All Steel Construction



Severe Duty WD™ Industrial Floor Machine

Stripping, Scrubbing, Resurfacing



Merlin takes advantage of innovative engineering and modern design to set new records in production and user safety. Our unique “Floating Head” handle carriage design provides 100% contact with the floor and steers the Glide in forward-and-backward movement - unlike the side-to-side movements of traditional rotary machines.

Power

- 1.5 HP, 180 frame, TEFC dual capacitor AC motor
- 115-230V, 60 Hz (50 Hz optional)
- 50 ft. 2-pc. 12-3 SJTOW industrial power cord

Drive System

- Triple-planetary XHD 11:1 helical-cut industrial gears, case hardened with steel coupler
- Gears drive brushes and pads at 165 RPM

Engineered Design

- WD™ Wheels Down handle disassembles in 60 seconds without tools, for transport and storage
- All steel construction with welded “Floating Head” frame
- Heavy duty powder-coated steel handle with 5-position pin lock
- The heavy duty motor guard mounts on the motor to protect from impact damage
- 17” and 20” steel brush covers with full wraparound bumper
- Private branding - 7 color plus chrome brush covers
- Thumb-operated safety switch. Dual steel operating triggers.
- Negative pressure on/off switch
- 2” x 8” non-marking load bearing, ball bearing wheels
- Includes 80 lb. weight set
- Increase productivity with the optional solution tanks

Safety Features

- Quiet 66 dB operation. Meets GS42 standard.
- UL/CUL listed



Specifications

	HP1517-180-MER	HP1520-180-MER
Model #	HP1517-180-MER	HP1520-180-MER
Part #	F0040-17 -1.5TE	F0040-20-1.5TE
Machine Size	17”	20”
Pad Size	16”	19”
Rotary Brush Size	15”	18”
Pad Speed	165 RPM	165 RPM
Amp Draw	7.9 Amp	8.5 Amp
All Sizes		
Motor	1.5 HP, 180 frame, TEFC dual capacitor AC motor	
Drive System	Triple-Planetary XHD 11:1 helical cut industrial gears	
Power	115-230V, 60 Hz (50 Hz optional)	
Power Cord	50 ft. 2-pc. 12-3 SJTOW industrial power cord	
dB Rating	66 dB - Meets GS42 standard	

Subject to Change Without Notice

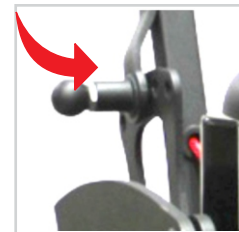

5-Position Pin Lock Handle
All Steel Construction



80 lb. Weights Mounts on
Apron with Locking Pins



Power for Optional
Grinder and Scraper Tools



Floating Head Frame



Dual Speed WD™ Industrial Floor Machine

Stripping, Scrubbing, Restoration



(4) 20#
Weights
Included

The Merlin 2-Speed takes advantage of innovative engineering to set new records in production and user safety. Our unique “Floating Head” handle carriage design provides 100% contact with the floor, incorporating forward movement instead of the traditional side-to-side buffing. The Merlin draws 1/3 less amps than standard machines. Strip and scrub floors at 165 RPM. Buff and polish at 300 RPM.

Power

- 1.5 HP, 66 frame, DC rectified 2-speed motor
- Hi-Lo 2-speed toggle switch on motor
- 115V, 50/60 Hz (230V optional)
- 50 ft. 12-3 SJTOW power cord with molded plug

Drive System

- Triple planetary XHD 11:1 helical cut industrial gears, case hardened with steel coupler
- Gears drive brushes and pads at 165 and 300 RPM

Engineered Design

- WD™ Wheels Down 5-position pin-lock handle disassembles in 60 seconds without tools, for transport and storage
- All steel construction with welded powder coated frame
- Includes removable 80# weight set
- 17” and 20” steel brush cover with wraparound bumper
- Private branding - 7 color plus chrome brush covers
- Thumb-operated safety switch. Negative pressure on/off switch. Dual steel operating triggers.
- 2” x 8” non-marking load bearing, ball bearing wheels

Safety Features

- Quiet operation – 66 dB (low speed), 72dB (high speed) Meets GS42 standard.
- UL / CUL Listed



Specifications

Model #	HP1517-MER-2SXHD	HP1520-MER-2SXHD
Part #	F0040-17-1.5TE-2S	F0040-20-1.5TE-2S
Machine Size	17 inch	20 inch
Pad Size	16 inch	19 inch
Pad Speed	165 / 300 RPM	165 / 300 RPM
Amp Draw (Low/High Speed)	8.5 / 9.1 Amp	9.2 / 9.6 Amp
All Sizes		
Motor	1.5 HP, 66 frame, DC rectified 2-speed motor	
Power	115V, 50/60 Hz (230V optional)	
Drive System	Triple-planetary XHD 11:1 helical cut industrial gears	
Power Cord	50 ft. 12-3 SJTOW power cord with molded plug	
dB Rating	66 dB (low speed) - 72 dB (high speed) operation Meets GS42 standard	

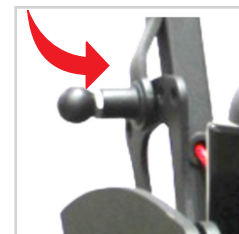

5-Position Pin Lock Handle
All Steel Construction



Optional 4 Gallon
Solution Tank
5 Stock Colors

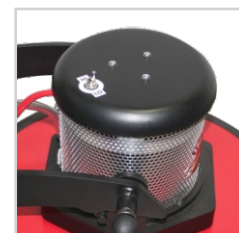

2-Speed Motor with
Hi/Lo Switch



80 lb. Weights Mounts on
Apron with Locking Pins

Subject to Change Without Notice



Dry Stripping, Scrubbing, Stripping

The Hawk G2 Raptor has a revolutionary rectangular head and is easy to maneuver with less vibration and fatigue than other orbiting brands. The G2 Raptor easily reaches into corners and along baseboards.

The Hawk G2 Raptor can strip floor finish without chemicals. It is excellent for sanding, scrubbing and stone polishing. Easy to learn. Easy to use.

Power

- 1.5 HP, 180 frame, TEFC dual capacitor AC motor
- 115-230V, 60 Hz
- 50 ft. 2-pc. 12-3 SJTOW industrial power cord with molded plug

Drive System

- Eccentric balanced orbital drive works at 1740 RPM

Engineered Design

- Four 2" vibration isolators
- One-piece industrial, powder-coated, heavy-duty welded steel frame and chromed steel handle for optimum durability
- Variable position handle lock with transport lock
- Thumb operated safety switch
- Negative pressure on/off switch
- Dual steel operating triggers
- 2" x 8" non-marking, ball bearing wheels
- Optional dust skirt and vacuum assembly kit

Safety

- Quiet 66 dB operation. Meets GS42 standard.
- UL/CUL listed



Specifications

Model	RAPTOR 2014-G2
Part Number	F-RAP2014-G2
Pad Size	20" x 14"
Pad Speed	1740 RPM
Power Source	115-230V, 60 Hz
Motor	1.5 HP, 180 frame, TEFC dual capacitor AC motor
Amp Draw	9 Amp
Power Cord	50 ft. 2-pc. 12-3 SJTOW industrial cord w/ molded plug
Weight	194 lbs. (0.657 lbs/in ²)
Drive System	Essentric balanced orbital drive
Vibration Isolators	(4) Industrial 2" vibration isolators
dB Rating	66 dB - Meets GS42 standard

Subject to Change Without Notice

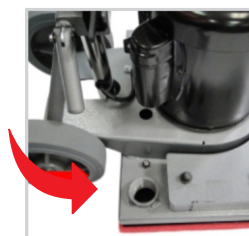

Milled Dust Control



Optional Dust Control Kit



8" Wheels for Easy Transport



Industrial 2" Vibration Isolators



Dry Stripping, Scrubbing, Stripping

The TigerHawk 1410 revolutionary rectangular “floating head” is easy to maneuver with less vibration and fatigue than other orbiting brands. The WD™ handle design assures 100% pad contact with the floor. The 1410 works three times faster than rotary floor machines, easily reaching into corners and along baseboards. Add the optional 2.5 gallon solution tank for even greater productivity.

The TigerHawk 1410 can strip large areas of floor finish without chemicals. The 1410 is excellent for sanding, scrubbing and stone polishing. Easy to learn. Easy to use.

Power

- 0.5 HP, 56 frame, TEFC single capacitor AC motor
- 115-230V, 60 Hz
- 50 ft. 2-pc. 14-3 SJT power cord with molded plug

Drive System

- Eccentric balanced orbital drive works at 1725 RPM

Engineered Design

- Dual vibration isolation system
- Heavy duty powder-coated steel handle with 5-position pin lock
- Built with vacuum port
- Thumb-operated safety switch
- Dual steel operating triggers
- Negative pressure on/off switch
- 1" x 5" non-marking ball bearing wheels
- Optional dust skirt and vacuum assembly kit

Safety Features

- Quiet 66 dB operation. Meets GS42 standard.
- Built with UL listed components



Specifications

Model #	TH-1410
Part #	F-TIGER1410
Pad Size	14" x 10"
Pad Speed	1725 RPM
Wt. - Down Pressure	172 lbs. - 0.61 lbs./sq. in.
Motor	0.5 HP, 56 frame, TEFC single capacitor AC motor
Power Source	115-230V, 60 Hz
Power Cord	50 ft. 2-pc. 14-3 SJT power cord w/molded plug
Amp Draw	8.3 Amp
Drive System	Eccentric balanced orbital drive
Vibration Isolators	(4) 1.25" isolators
dB Rating	66 dB - Meets GS42 standard

Subject to Change Without Notice



Floating Head Frame



Optional Full Wraparound Dust Skirt

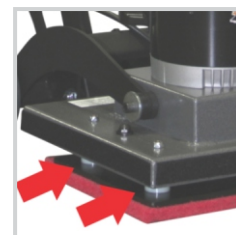

(4) Rubber Vibration Isolators

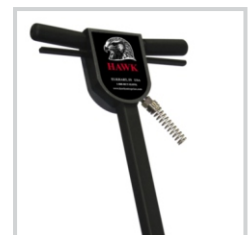

Welded Powder-Coated Steel Construction



TigerHawk 2014 Deluxe Orbital Floor Machine

Dry Stripping, Scrubbing, Stripping



The TigerHawk 2014 with the revolutionary rectangular “floating head” design is easy to maneuver, with less vibration, sound and operator fatigue than other orbiting brands. Works faster than rotary machines, easily reaches into corners and along baseboards. Use the spray system model (TH2014-SP) or active vacuum system model (TH2014-V) for even greater productivity. Add the 4.5 gallon solution tank for wet scrubbing. Strip large areas of floor finish with or without chemicals. The 2014 is excellent for sanding, scrubbing and stone stripping.

Power

- 1.5 HP, 180 frame, TEFC dual capacitor AC motor
- 115-230V, 60 Hz
- 50 ft. 2-pc. 12-3 SJTOW industrial power cord with molded plug

Drive System

- Eccentric balanced orbital drive works at 1725 RPM

Engineered Design

- Dual vibration isolation system
- Heavy duty powder-coated steel handle with 5-position pin lock
- The WD™ handle is easy to remove for transport and storage
- The severe-duty motor guard to protect from impact damage
- Includes easy to move transport cart
- The severe-duty motor guard mounts on the motor
- 2” x 8” non-marking ball bearing wheels
- The 2014 frame is built with a vacuum port. The 2014 “V” model connects here with 6 quart tank vacuum and dust skirt.
- The 2814 “SP” model adds motor-mounted solution pump and handle-mounted 4.5 gallon solution tank

Safety Features

- Quiet 60 dB operation. Meets GS42 standard.
- UL/CUL listed



Specifications

Model	TH-2014	TH2014-SP	TH2014-V
Part Number	F-TIGER2014	F-TIGER 2014-SP	F-TIGER2014-V
Pad Size	20” x 14”	20” x 14”	20” x 14”
Configuration	Standard	w/ Solution Pump & 4.5 Gal. Solution Tank	w/ 6 Qt. Tank Vacuum & Skirt
Pad Speed	1740 RPM	1740 RPM	1740 RPM
Amp Draw	7.1 Amp	7.1 Amp	11.8 Amp
Weight	250 lbs.	259 lbs.	269 lbs.
Pad Pressure	0.89 lbs/in ²	0.92lbs/in ²	0.96 lbs/in ²

All Models

Motor	1.5 HP, 180 frame, TEFC dual capacitor AC motor
Power Source	115-230V, 60 Hz
Power Cord	50 ft. 2-pc. 12-3 SJTOW industrial power cord w/molded plug
Drive System	Eccentric balanced orbital drive
Vibration Isolators	(6) primary, (8) secondary isolaters
dB Rating	60 dB - Meets GS42 standard

Subject to Change Without Notice



TH2014-V Model Adds the 6 Quart Tank Vac and Dust Skirt



TH2014-SP Model Adds the Spray Pump and Solution Tank



Steel Frame with Rear Vacuum Port



Works Along Baseboards and Into Corners



Dry Stripping, Scrubbing, Stripping



The TigerHawk 2814 with the revolutionary rectangular “floating head” design is easy to maneuver, with less vibration, sound and operator fatigue than other orbiting brands. Works 3 times faster than rotary machines, easily reaches into corners and along baseboards. Use the spray system model (TH2814-SP) or active vacuum system model (TH2814-V) for even greater productivity. Strip large areas of floor finish with or without chemicals. The 2814 is excellent for sanding, scrubbing and stone stripping.

Power

- 1.5 HP, 180 frame, TEFC dual capacitor AC motor
- 115-230V, 60 Hz
- 50 ft. 2-pc. 12-3 SJTOW industrial power cord with molded plug

Drive System

- Eccentric balanced orbital drive works at 1740 RPM

Engineered Design

- Dual vibration isolation system
- Heavy duty powder-coated steel handle with 5-position pin lock
- The WD™ handle is easy to remove for transport and storage
- The severe-duty motor guard to protect from impact damage
- Includes easy to move transport cart
- Thumb-operated safety switch. Dual steel operating triggers.
- Includes full wraparound dust skirt
- 2” x 8” non-marking ball bearing wheels
- The 2814 frame is built with dual vacuum ports. The 2814 “V” model connects here with 6 quart tank vacuum and dust skirt.
- The 2814 “SP” model adds motor-mounted solution pump and handle-mounted 4.5 gallon solution tank

Safety Features

- Quiet 60 dB operation. Meets GS42 standard.
- UL/CUL listed



Specifications

Model	TH-2814	TH2814-SP	TH2814-V
Part Number	F-TIGER2814	F-TIGER 2814-SP	F-TIGER2814-V
Pad Size	28” x 14”	28” x 14”	28” x 14”
Configuration	Standard	w/ Solution Pump & 4.5 Gal. Solution Tank	w/ 6 Qt. Tank Vacuum & Skirt
Pad Speed	1740 RPM	1740 RPM	1740 RPM
Amp Draw	7.8 Amp	7.8 Amp	12.5 Amp
Weight	305 lbs.	314 lbs.	324 lbs.
Pad Pressure	0.78 lbs/in ²	0.80lbs/in ²	0.82 lbs/in ²

All Models

Motor	1.5 HP, 180 frame, TEFC dual capacitor AC motor
Power Source	115-230V, 60 Hz
Power Cord	50 ft. 2-pc. 12-3 SJTOW industrial power cord w/molded plug
Drive System	Eccentric balanced orbital drive
Vibration Isolators	(8) primary, (8) secondary isolaters
dB Rating	60 dB - Meets GS42 standard



TH2814-V Model Adds the 6 Quart Tank Vac and Dust Skirt



TH2814-SP Model Adds the Spray Pump and Solution Tank

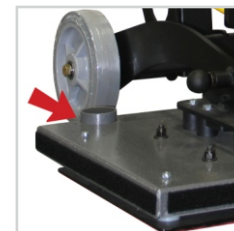

Frame is Built with Dual Vacuum Ports



Includes Transport Cart

Subject to Change Without Notice



Surface Preparation, Scrubbing, Refinishing



The RedTail 2014-180 is great for surface preparation and deep cleaning of any hard surface. Strip large areas of floor finish with or without chemicals. Use dry or wet as your program requires. Excellent for surface refinishing, scrubbing ceramic tile and grout, sanding wood and stone polishing. Easy to learn and operate by any personnel, experienced or new.

Our unique WD™ Wheels Down “Floating Head” design provides 100% pad contact on the floor for perfect control. 12 severe-duty isolators work in concert to absorb vibration and reduce operator fatigue. The thick steel face plate resists distortion under heavy use and friction heat. Exclusive 2" rear dust plenum maximizes dust collection via vacuum. The handle and carriage is easily removed for transport and storage. Total unit weight is 171 lbs.

Power

- 1.5 HP, 60 Hz, 180 frame, TEFC dual capacitor AC motor
- 115-230V, 60 Hz
- 50 ft. 14-3 commercial power cord with molded plug

Drive System

- Direct drive balanced eccentric with sealed bearing
- 6 primary isolators and 6 secondary isolators

Engineering Design

- Hawk exclusive orbital technology reduces vibration and makes scrubbing easier with less fatigue
- WD™ Wheels Down Floating Head allows full pad contact with the floor maximizing performance
- Heavy-duty powder-coated steel handle with 5-position pin-set lock
- Thumb operated safety switch. Dual steel operating triggers.
- Negative pressure on/off switch
- 2" x 6" non-marking ball bearing wheels
- Optional dust control kit **#HP0031-DC-TIGER**
- Optional vacuum and dust control kit **#TH1011-RT**
- Optional 4 Gallon Solution Tank **#A0001-NAT4-QRGF**

Safety Features

- Quiet 66 dB operation. Meets GS42 standard.
- Built with UL approved components



Specifications

Model#	RedTail 2014-180
Part#	#F-98-RT160
Pad Size	20" x 14"
Pad Speed	1740 RPM
Amp Draw	7.1 Amp
Motor	1.5 HP, 180 frame, TEFC dual capacitor AC Power
Power Source	115-230V, 60 Hz
Power Cord	50 ft. 14-3 commercial power cord w/ molded plug
Weight	171 lbs.
Pad Pressure	0.61 lbs/in ²
Drive System	Direct drive balanced eccentric with sealed bearing
Vibration Isolator	(6) primary, (6) secondary
dB Rating	60 dB - Meets GS42 standard

Subject to Change Without Notice



Works Along Baseboards and Into Corners



Disassembles Without Tools for Easy Transport & Storage

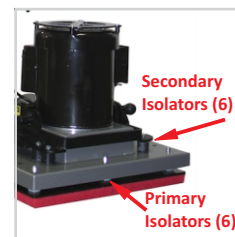

Unique Vibration Damping Design



Optional Dust Control Kit Skirt and Vacuum Hardware



Burnishing & Refinishing



The Hawk High Speed is known for its balance, durability, and value. Hawk offers the largest selection of burnishers. Available in 13", 15", 17" & 20". Choose your speed - 1500, 1800 or 2000 RPM. The 17" and 20" Semi-Active Dust Control DC models include a dust ring and filter; the perfect addition to any Green Cleaning program.

Power

- 1.5 HP, 66 frame, DC rectified motor
- 115V, 50/60 Hz (230V optional)
- 50 ft. 14-3 STO industrial power cord with molded plug

Drive System

- Multi V-Belt drives pads at 1500, 1800 and 2000 RPM

Engineering Design

- Welded steel frame. One piece chrome heavy-duty steel handle with variable position positive lock.
- 13", 15", 17" and 20" steel brush covers with full wraparound bumper
- Private branding - 7 color plus chrome brush covers
- Thumb operated safety switch. Negative pressure on/off switch.
- Dual steel operating triggers
- 1" x 5" non-marking ball-bearing wheels
- 17" and 20" Dust Control models include a dust ring and filter
- Includes flexible pad holder with pad centering clamp

Safety Features

- Quiet operation - 69 dB (Standard), 62 dB (Dust Control). Meets GS42 standard.
- UL/CUL listed (1500 rpm model)



Specifications

Machine Pad Size	13" Standard 13"	15" Standard 15"	17" Standard 17"	17" Dust Control 16"	20" Standard 20"	20" Dust Control 19"
Speed	1500 RPM					
Model #	HP1513-HSB	HP1515-HSB	HP1517-HSB	HP1517-1500HSBDC	HP1520-HSB	HP1520-1500HSBDC
Part #	F1500-13	F1500-15	F1500-17	F1500-17DC	F1500-20	F1500-20DC
Amp Draw	9.1 Amp	9.6 Amp	13.0 Amp	12.2 Amp	13.8 Amp	13.1 Amp
Speed	1800 RPM					
Model #	HP1513-1800	HP1515-1800	HP1517-1800	HP1517-1800DC	HP1520-1800	HP1520-1800DC
Part #	F1800-13	F1800-15	F1800-17	F1800-17DC	F1800-20	F1800-20DC
Amp Draw	9.5 Amp	9.9 Amp	13.9 Amp	13.2 Amp	14.6 Amp	13.6 Amp
Speed	2000 RPM					
Model #	HP1513-2000	HP1515-2000	HP1517-2000	HP1517-2000DC	HP1520-2000	HP1520-2000DC
Part #	F2000-13	F2000-15	F2000-17	F2000-17DC	F2000-20	F2000-20DC
Amp Draw	10.0 Amp	10.8 Amp	14.9 Amp	13.9 Amp	16.4 Amp	14.8 Amp

All Models

Motor	1.5 HP, 66 frame DC rectified motor					
Power Source	115V, 50/60 Hz (230V optional)					
Power Cord	50 ft. 14-3 STO industrial power cord with molded plug					
Belt Drive	Multi-V belt drive					
dB Rating	69 dB	69 dB	69 dB	62 dB	69 dB	62 dB
Machine Weight (all)	84 lbs.	86 lbs.	88 lbs.	90 lbs.	90 lbs.	92 lbs.

Subject to Change Without Notice



Burnishing & Refinishing



The Hawk High-Speed Burnisher with AC motor is a balanced force of polishing power. The models are built with a durable 1.5 HP Totally Enclosed Fan Cooled (TEFC) motor that requires no maintenance. The enclosure protects the inner working of the motor from dust and moisture. The perfect addition to any Green Cleaning program.

Power

- 1.5 HP, 56 frame, TEFC dual capacitor AC motor
- 115-230V, 60 Hz
- 50 ft. 14-3 STO industrial power cord

Drive System

- Multi V-Belt drives pads at 1000, 1250 and 1500 RPM

Engineering Design

- Welded steel frame. One-piece chrome handle with variable position positive lock handle and vinyl grips
- 13", 15", 17" and 20" steel brush cover with full wraparound bumper
- Private branding - 7 color plus chrome brush covers
- Thumb-operated safety switch. Negative pressure on/off switch.
- Dual steel operating triggers
- 1" x 5" non-marking wheels
- 17" and 20" Dust Control models include a dust ring and filter
- Includes flexible pad holder with pad centering clamp
- Optional splash guard

Safety Features

- Quiet operation - 58 dB (Standard), 53 dB (Dust Control). Meets GS42 standard.
- Built with UL listed components



ELKHART, IN



Specifications

Machine Pad Size	13" Standard 13"	15" Standard 15"	17" Standard 17"	17" Dust Control 16"	20" Standard 20"	20" Dust Control 19"
Speed	1000 RPM					
Model #	HP1513-1000	HP1515-1000	HP1517-1000	HP1517-1000DC	HP1520-1000	HP1520-1000DC
Part #	F1000-13TE	F1000-15TE	F1000-17TE	F1000-20TE	F1000-17TE	F1000-20TEDC
Amp Draw	10.0 Amp	11.2 Amp	12.4 Amp	11.6 Amp	13.5 Amp	12.4 Amp
Speed	1250 RPM					
Model #	HP1513-1250	HP1515-1250	HP1517-1250	HP1517-1250DC	HP1520-1250	HP1520-1250DC
Part #	F1250-13TE	F1250-15TE	F1250-17TE	F1250-20TE	F1250-17TE	F1250-20TEDC
Amp Draw	10.0 Amp	11.2 Amp	12.4 Amp	11.6 Amp	13.5 Amp	12.4 Amp
Speed	1500 RPM					
Model #	HP1513-1500	HP1515-1500	HP1517-1500	HP1517-1500	-	-
Part #	F1500-13TE	F1500-15TE	F1500-17TE	F1500-20TE	-	-
Amp Draw	10.3 Amp	11.7 Amp	13.0 Amp	12.3 Amp	-	-
All Models						
Motor	1.5 HP, 56 frame, TEFC dual capacitor AC motor					
Power Source	115-230V, 60 Hz					
Power Cord	50 ft. 14-3 STO industrial power cord with molded plug					
Belt Drive	Multi-V belt drive					
dB Rating	58 dB	58 dB	58 dB	53 dB	58 dB	53dB
Machine Weight (all)	84 lbs.	86 lbs.	88 lbs.	88 lbs.	90 lbs.	90 lbs.

Subject to Change Without Notice



High Speed Burnisher w/ DC Motor

Burnishing & Refinishing



The Hawk Centerfold High-Speed Burnisher with DC motor is renowned for its balance, durability and value. The non-locking handle allows the head to keep constant pad pressure assuring a steady amp draw and consistent floor shine. The fold-up handle is designed for easy transport and for storage in tight spaces. Available in 4 sizes and 3 speeds. The 17" and 20" Active Dust Control models include a dust ring and filter, the perfect addition to every Green Cleaning program.

Power

- 1.5 HP, 66 frame, DC rectified motor
- 115V, 50/60 Hz (230V optional)
- 50 ft., (14-3) SJT industrial power cord with molded plug

Drive System

- Multi V-Belt drives pads at 1500, 1800 or 2000 RPM

Engineered Design

- Built with welded, heavy gauge industrial powder coated steel
- Variable position handle with vinyl grips
- 13", 15", 17" and 20" brush cover with full wraparound bumper
- Active Dust Control on 17" and 20" models
- Thumb operated safety switch. Negative pressure on/off switch.
- Dual steel operating triggers
- 1" x 5" non-marking ball bearing wheels
- Includes flexible pad holder with pad centering clamp
- Optional splash guard, dust filter, polishing and burnishing pads

Safety Features

- Quiet operation - 69 dB (Standard), 62 dB (Dust Control). Meets GS42 standard
- UL/CUL listed.



Specifications

Machine Pad Size	13" Standard 13"	15" Standard 15"	17" Standard 17"	17" Dust Control 16"	20" Standard 20"	20" Dust Control 19"
Speed	1500 RPM					
Model #	HCF1513-1500	HCF1515-1500	HCF1517-1500	HCF1517-1500DC	HCF1520-1520	HCF1520-1520DC
Part #	F1500-13CF	F1500-15CF	F1500-17CF	F1500-17CFDC	F1500-20CF	F1500-20CFDC
Amp Draw	11.4 Amp	11.9 Amp	12.6 Amp	9.8 Amp	13.2 Amp	10.2 Amp
Speed	1800 RPM					
Model #	HCF1513-1800	HCF1515-1800	HCF1517-1800	HCF1517-1800DC	HCF1520-1800	HCF1520-1800DC
Part #	F1800-13CF	F1800-15CF	F1800-17CF	F1800-17CFDC	F1800-20CF	F1800-20CFDC
Amp Draw	11.7 Amp	12.3 Amp	13.2 Amp	10.1 Amp	13.9 Amp	10.7 Amp
Speed	2000 RPM					
Model #	HCF1513-2000	HCF1515-2000	HCF1517-2000	HCF1517-2000DC	HCF1520-2000	HCF1520-2000DC
Part #	F2000-13CF	F2000-15CF	F2000-17CF	F2000-17CFDC	F2000-20CF	F2000-20CFDC
Amp Draw	11.8 Amp	12.4 Amp	13.8 Amp	11.1 Amp	14.8 Amp	11.8 Amp
All Models						
Motor	1.5 HP, 66 frame, DC rectified motor					
Power Source	115V, 50/60 Hz (230V optional)					
Power Cord	50 ft., (14-3) SJT industrial power cord with molded plug					
Belt Drive	Multi-V belt drive					
dB Rating	69 dB	69 dB	69 dB	62 dB	69 dB	62 dB
Machine Weight	84 lbs.	86 lbs.	88 lbs.	90 lbs.	90 lbs.	92 lbs.

Subject to Change Without Notice



Stripping, Scrubbing, Buffing



The BlackHawk has been redesigned for easy transport in today's smaller vehicles. The exclusive Pin-Set™ Handle Lock does away with nuisance adjustments that are common with friction handle locks. Steel construction with commercial-quality components include ball bearing wheels, commercial grade cord and grips, a solid steel handle lock and the durable 1.5 HP dual-capacitor motor. The BlackHawk buffer can deliver 24/7 reliable results for years to come.

Power

- 1.5 HP, 66 frame, dual capacitor AC motor
- 115-230V, 60 Hz
- Strain relief 14-3 STO power cord

Drive System

- Triple-planetary 10:1 helical-cut commercial gears drive pads and brushes at 175 RPM

Engineered Design

- The all steel detachable handle with pin-set handle lock disassembles in 60 seconds, no tools required.
- Quality welded steel construction
- Pin Set™ Handle Lock adjusts the handle to 4 heights
- 17" or 20" brush covers. 360 degree wraparound bumpers.
- Thumb-operated safety switch. Dual steel operating trigger.
- Negative pressure on/off switch
- Optional 4 gallon solution tank in 5 stock colors
- Optional Splash Guard #SPLASH17 or #SPLASH20
- Sturdy 1" x 5" non-marking ball bearing wheels
- Includes Hawk Lok™ molded plastic pad driver

Safety Features

- Quiet 62 dB operation. Meets GS42 standard.
- Built with UL approved components

Specifications

Model #	BLKHWK17	BLKHWK20
Part #	F0009-BH2P	F0012-BH2P
Machine Size	17"	20"
Pad Size	16"	19"
Pad Speed	175 rpm	175 rpm
Amp Draw	5.9 Amp	6.5 Amp

All Models

Motor	66 frame, 1.5 HP dual capacitor AC motor
Power Source	115-230V, 60 Hz
Power Cord	50 ft. 14-3 STO power cord with molded plug
Drive System	Triple-planetary 10:1 helical-cut gears
dB Rating	62 dB - Meets GS42 standard

Subject to Change Without Notice



Remove/Install the Handle in 60 Seconds



Exclusive Pin-Set™ Handle Lock - 4 Height Settings



Remove the Handle Mounting Pin w/o Tools



Includes Hawk Lok™ Pad Driver



Burnishing, Refinishing



The BlackHawk 1250 Burnisher drives a 20" pad at 1250 RPM for efficient polishing of all hard floor finishes. The 1.5 HP 56 frame DC motor is powerful. The welded steel frame and chromed handle are durable and reliable. It is remarkably easy to handle and can be used on all types of hard floors. It is powered by a durable 1.5 HP TEFC (Totally Enclosed Fan Cooled) AC motor that requires little maintenance with a motor shroud that protects the inner working from dust and moisture.

Power

- 1.5 HP, 56 frame, TEFC dual capacitor AC motor
- 115-230V, 60 Hz
- 50 ft. 14-3 STO power cord with molded plug

Drive System

- V-Belt drives pads at 1250 RPM

Engineering Design

- Welded heavy gauge steel frame
- One piece chromed heavy-duty steel handle
- Molded plastic pad cover with wraparound bumper
- Thumb-operated safety switch. Comfortable vinyl grips.
- Negative pressure on/off switch. Dual steel operating triggers.
- Multiple position handle adjustment
- Non-marking 1" x 5" non-marking ball bearing wheels
- Includes style flexible pad driver with spring-style pad centering clamp (#KIT2014)

Safety Features

- Quiet operation - 58 dB. Meets GS42 standard.
- Built with UL listed components



ELKHART, IN

Specifications

Model	BLKHWK 1250
Part#	F1250-20TE-BH
Motor	56 frame, 1.5 HP TEFC dual capacitor AC Motor
Drive System	Multi V-Belt Drive
Power Source	115-230V, 60 Hz
Power Cord	50 ft. 14-3 STO power cord with molded plug
Pad Size	20"
Pad Speed	1250 RPM
Construction	Steel frame, molded plastic brush cover
Amp Draw	11.2 Amp
dB Rating	58 dB - Meets GS42 Standard
Weight	90 lbs.

Subject to Change Without Notice



All Steel Construction Handle, Frames

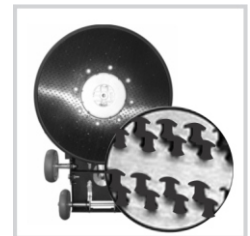

Flexible Pad Driver with Pad Centering Clamp



Use with 20" Hogs Hair Pads and Centering Clamp



Optional Splash Guard #SPLASH20 - 20"



Burnishing, Refinishing



The BlackHawk 1500 Burnisher drives a 20" pad at 1500 RPM for efficient polishing of all hard floor finishes. The 1.5 HP 66 frame DC motor is powerful. The welded steel frame and chromed handle are durable and reliable.

Power

- 1.5 HP, 66 frame, DC rectified motor
- 115V, 50/60 Hz
- 50 ft. 14-3 STO industrial power cord with molded plug

Drive System

- A 10-groove V-Belt drives pads at 1500 RPM

Engineering Design

- Welded heavy gauge steel frame
- One piece chromed heavy-duty steel handle
- Molded plastic brush cover with wraparound bumper
- Thumb-operated safety switch
- Comfortable vinyl grips
- Negative pressure on/off switch. Dual steel operating triggers.
- Multiple position handle adjustment
- Non-marking 1" x 5" non-marking ball bearing wheels
- Includes flexible pad driver with spring-style pad centering clamp (**KIT2014**)

Safety Features

- Quiet operation - 66 dB. Meets GS42 standard.
- Built with UL listed components



ELKHART, IN



Specifications

Model	BLKHWK 1500
Part#	F1500-20-BH
Motor	1.5 HP, 66 frame DC rectified motor
Drive System	Multi V-belt drive
Power Source	115V, 50/60 Hz
Power Cord	50 ft. 14-3 STO power cord with molded plug
Pad Size	20"
Pad Speed	1500 RPM
Amp Draw	13.5 Amp
dB Rating	66 dB - Meets GS42 standard
Weight	92 lbs.

Subject to Change Without Notice



All Steel Construction
Handle, Frames



Flexible Pad Driver
with Pad Centering Clamp



Use with 20" Hogs Hair
Pads and Centering Clamp



Optional Splash Guard
SPLASH20 - 20"



Dry Floors, Circulate and Exhaust Air

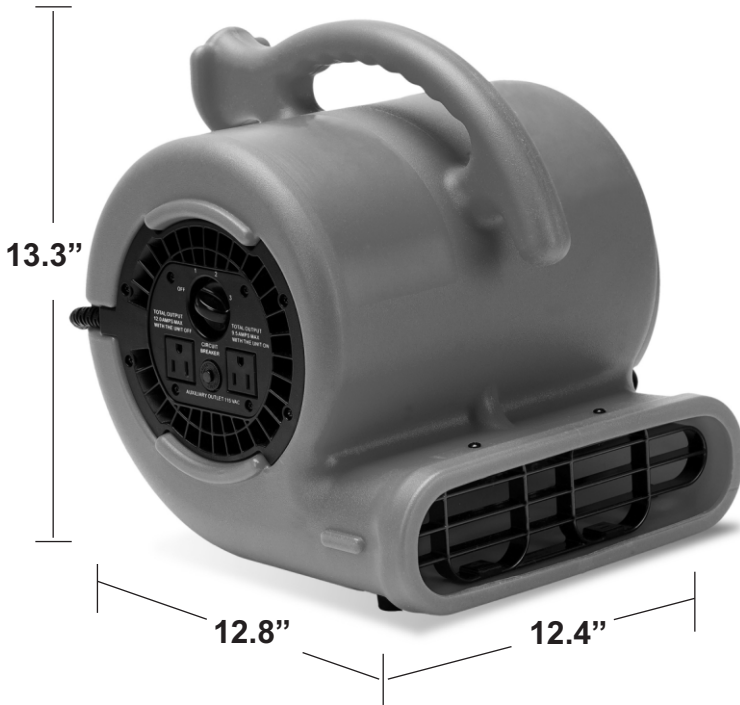

HAWK BVP25D
900 CFM Air Mover

The new Hawk BVP25D air mover is designed for small to medium size jobs. Ideal for ventilating hard to reach areas using its robust 1/4 HP induction motor and choice of three air flow positions. The 3-speed motor moves air up to 900 CFM.

Two 12 Amp auxiliary power outlets on the side-mounted control panel makes it easy to connect up to 5 unit in daisy chain operation. Quiet - 67 dB

Engineered Design

- 3-Speed, 1/4 HP motor with 10 ft. 14 AWG power cord
- 3-speed switch and circuit breaker on control panel
- Up to 900 CFM air flow
- Two 12 Amp grounded auxiliary power outlets on the side-mounted control panel
- Daisy chain in-line connection of up to 5 units for more effective, focused air flow
- Strong rotomolded chassis has a profile that allows for vertical stacking of up to 5 units for convenient storage
- Ergonomic handle for easy transport
- Lightweight 11.3 lbs.
- Quiet operation - 67 dB
- C-ETL-US certification
- 5 year warranty on rotomolded chassis. 2 year warranty on parts.



Specifications

Model	BVP25D
Motor	1/4 HP, 115V, 60Hz
Air Volume	900 CFM (High), 700 CFM (Med), 690 CFM (Low Speed)
Amp Draw	2.1 Amp (High), 1.8 Amp (Med), 1.7 Amp (Low Speed)
Air Flow Direction	0, 45 and 90 degrees
Max Static Pressure	1.3"
Frame Construction	Sturdy Rotomolded Plastic
Stackable	5 units
Daisy Chain	Yes - Up to 5 Units
Weight	11.3 lbs. (net) / 12.6 lbs. (gross)
Size (LxWxH)	12.8" x 12.4" x 13.3"
Attached Cord	10 Ft. 14 AWG
Sound Level	67 dB
Certification	C-ETL-US

Subject to Change Without Notice



Side Mount
3-Speed Switch and
Dual 110V Power Outlets



Daisy Chain up to
5 Units for Extra Air
Moving Power



Air Flow in 3 Angles
0, 45 & 90 Degrees



Works in Tight Spaces for
Tough Drying Jobs



Dry Floors, Circulate and Exhaust Air

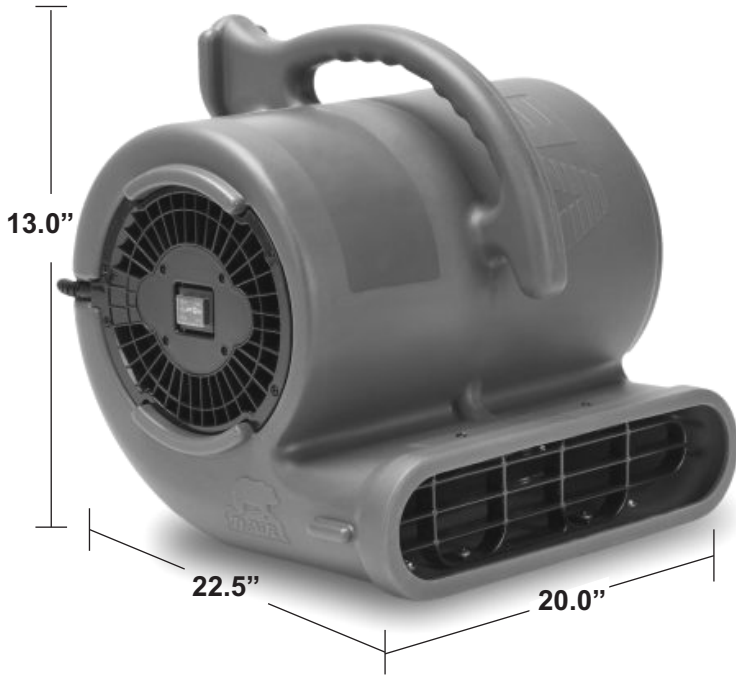

HAWK BVP50
2820 CFM Air Mover



HAWK BVP50H
with Handle and
Transport Wheels



The safest and most efficient centrifugal air mover on the market. Our 1/2 HP motor generates up to 2820 CFM with just 4.5 amps usage. Control the CFM and Amp draw with our state of the art 2-speed moisture resistant switch. The rotationally molded body is stronger, lighter and capable of stacking 4 high in storage. Available with convenient telescoping cart (BVP50H).

Engineered Design

- The 1/2 HP, 2-Speed motor is efficient and produces up to 2820 CFM airflow
- 25 ft. 16 AWG power cord
- The motor is sealed to prevent moisture from entering and damaging internal motor components
- The side-mounted 2-speed switch is moisture resistant
- Sturdy Roto-Molded plastic design has a profile that allows for vertical stacking up to 5 units for convenient storage
- The **BVP50** multipurpose design directs air at 3 angles (horizontally, 45° and 90°).
- The **BVP50H** adds a telescoping handle and transport wheels. Use horizontally, or tip back 90 degrees and move air straight upward.
- A plastic cage protects motor and fans from debris
- C-ETL listed

Specifications

Model	BVP50, BVP50H (with Telescoping Handle & Wheels)
Motor	1/2 HP, 115V, 60Hz
Air Volume	2820 CFM (High Speed) / 2390 CFM (Low Speed)
Amp Draw	4.5 Amp (High Speed) / 2.8 Amp (Low Speed)
Max Static Pressure	2.5"
Air Flow Direction	0, 45 and 90 degrees
Frame Construction	Sturdy Roto-Molded Plastic
Stackable	4 units
Weight	25 lbs. (net) / 28 lbs. (gross)
Size (LxWxH)	22.5"x 20"x 13"
Attached Cord	25 Ft. 16 AWG
Sound Level	74 dB
Certification	C-ETL-US

Subject to Change Without Notice



Store Up To
5 Stacked Units



BVP50H Adds Dual
Transport Wheels and
Telescoping Handle



Direct Airflow at 3 Angles
(Horizontally, 45° and 90°).

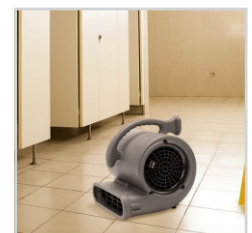

Quiet Janitorial Jobs
74 dB at High Speed



HAWK BPB25DA Axial
3320 CFM Air Mover



Dry Floors, Circulate and Exhaust Air

The Hawk BPB25A Axial moves air efficiently with less power and effort than other models. A built-in GFCI Auxiliary Outlet* reduces risk of electric shock in wet areas. The BPB25A shoots a beam of air 50 feet ahead. An optional mounting stand locks onto the chassis and allows for 360 degree rotation to move air in any direction.

*Required for use when Insurance Companies are paying for water and flood cleanup claims

Engineered Design

- 2-Speed, 1/4 HP motor. A sealed motor design prevents moisture from entering and damaging internal motor components.
- 25 ft. 14 AWG foot power cord
- Axial design is efficient and produces up to 3320 CFM
- Metal air intake screen prevents objects from entering and damaging blades or motor
- Two 12 Amp GFCI grounded auxiliary power outlets on the side-mounted control panel. GFCI reduce the risk of electric shock in wet areas and is required by insurance companies paying for water flood cleanup claims.
- "Daisy chain" in-line connection of up to 5 units for more effective air flow
- 2-speed toggle switch with LED light on/off indicator
- Hour meter on control panel tracks hours of operation
- Strong rotomolded chassis has profile that allows for vertical stacking of up to 5 units for convenient storage
- An optional folding metal frame with quick release locking knob allows easy adjustment for 360 degree airflow direction
- C-ETL US listed
- 2 year warranty on parts. 5 year on rotomolded chassis.

Specifications

Model	BPB25DA Axial
Motor	1/4 HP, 2-Speed, 115V, 60 Hz, Sealed Motor
Amp Draw	2.6 Amp (High Speed), 1.3 Amp (Low Speed)
Air Volume	3320 CFM Max
Air Flow Direction	360 degrees
Hour Meter	Yes
LED Power Indicator	Yes
Frame Construction	Sturdy Rotomolded Plastic
Stackable	5 units
Daisy Chain	Yes - Up to 5 Units
Weight	30 lbs. (net) / 34 lbs. (gross)
Size (L x W x H)	22.5" x 13" x 20"
Attached Cord	25 Ft. 14 AWG
Sound Level	78 dB
Certification	C-ETL-US

Subject to Change Without Notice



The Chassis is Rotomolded with a Profile for Stacking and Convenient Storage



Add the Folding Metal Frame to Direct Air at Every Angle



(2) GFCI Outlets and Convenient 2-Speed Switch



GFCI Shock-Preventing Outlets Make Daisy Chain Connection Easy



**HAWK BH25AD Axial
 1720 CFM Air Mover**

Dry Floors, Circulate and Exhaust Air

The BH25AD Axial Air Mover produces up to 1720 CFM airflow with a variable control dial switch. The low amp draw and dual built-in 12 amp power outlets allows for multiple units to be used in daisy chain. The metal rack/stand included provides 360-degree rotation for multiple positions when drying spaces or circulating air. Designed with a sealed motor to protect from contaminant and moisture damage.

The specially designed blades and fan grille excel in extending a powerful and focused straight stream of air up to 60 ft. This allows the proper amount of air flow for any task at hand.

Power

- 1/4 HP thermally protected
- Motor: 115V, 60 Hz
- Power: 1.6 AMP Low - 2.0 AMP High
- Cord: 20 ft.
- 12 AMP auxiliary outlet

Engineering Design

- Variable speed from 0 to 1720 CFM
- 360 degree adjustable positions
- Injection molded housing is lightweight and durable
- 33" diameter, ABS plastic fan blades (3)
- Stackable design up to 5 units high
- Lightweight for effortless transport

Safety Features

- Environmentally Responsible
- ETL/CETL Listed
- Motor Warranty - 6 months



Specifications

Model#	BH25AD
Motor	1/4 HP
Amp Draw	1.6 (Low), 2.0 (High)
Speed	0 to 1720 CFM
Fan Blades	(3) 16" ABS molded plastic blades
Housing	Injection molded chassis
Auxiliary Outlet	12 Amp with circuit breaker
Positions	360 degree
Power Cord	20 ft.
Weight	16.1 lbs.

Subject to Change Without Notice



Stackable Chassis



Direct Air at Every Angle



Moves Air Up To
60 Feet



Move More Air with Daisy
Chained Power



Dry Floors, Circulate & Exhaust Air



Hawk Industrial Air Mover with 1/2 HP, 3-speed industrial motor will move air consistently to 2950 CFM. Built with super-tough polypropylene housing for long-term use in the toughest of applications; construction, manufacturing and housekeeping applications. Metal cage and safety discharge guard.

Power

- 0.5 HP, 3-speed motor
- 115V, 50/60 Hz (230 V optional)
- 12 Amp draw with circuit breaker
- 25 ft. 16-3 SJTOW power cord with molded plug
- Top mounted, quick change 3-speed switch

Engineering Design

- Three air flow speeds - 2000 CFM, 2500 CFM and 2950 CFM with switch on housing
- Continuous-duty rugged ball bearing motor
- Polyethylene housing with extended warranty
- Plastic fan wheel
- Steel handle and air discharge guard
- 8 rubber feet for non-slip positioning
- Stackable for easy storage
- Convenient size - 19.5" x 14.5" x 18.25"
- Available in 2 colors; royal blue, and black. Special colors with 25 piece order.

Safety Features

- UL Listed
- Quiet operation with dB levels: Low 59, Medium 62, High 64. Meets GS42 standard.



Specifications

Model#	BH001-3S		
Part #	BH001-BLK, BH001-RYB		
Motor	0.5 HP, 3-speed motor		
Power	115V, 50/60 Hz (230 V optional)		
Motor CFM	2000 CFM	2500 CFM	2950 CFM
Amp Draw	4.3 Amp	4.5 Amp	5.3 Amp
Power Cord	25 ft. 16-3 SJTOW power cord w/molded plug		
Housing	Polyethylene housing		
Auxiliary Outlet	12 Amp with circuit breaker		
Positions	0, 45 and 90 degrees		
dB Rating	59 dB (low speed), 62 dB (medium), 64 dB (high). Meets GS42 standard.		
Size	19.5" x 14.5" x 18.25"		
Weight	31 lbs.		

Subject to Change Without Notice



Frame in Royal Blue and Black



Metal Carrying Handle



3-Speed Switch



HAWK Wet/Dry Commercial Tank Vacuum

Large Area Vacuum Cleaning

The Hawk 20 gallon and 55 gallon tank vacuums are built for years of trouble-free service. Perfect for large volume recovery of liquids and solid wastes.



20 Gallon Engineering Design

- The 20 gallon model is built with a strong roto-molded, easy to clean tank. The tank moves with (2) 10" wheels and (2) 4" front swivel casters, steered with the black powder-coated steel handle.
- Optional front-mount squeegee #V006FMS

55 Gallon Engineering Design

- The 55 gallon model uses a steel band dolly with four 4" caster wheels.
- Optional drain valve #V006-55VALVE

Both Models

- 2 HP, 2-stage, heavy duty bypass motor
- 115V, 60 Hz
- 50 ft. 16-3 SJT power cord
- An automatic liquid shut-off prevents motor flooding with foam or solution
- Includes wet/dry tool kit #HVWD20-117
- Includes one acid and mildew resistant, non-pleated washable synthetic cloth dust bag #WDH0001ASSY

Safety Features

- Quiet operation - 78 dB. Meets GS42 standard.



ELKHART, IN

Specifications

Model #	HVWD-20-117	HVWD-55-117
Part #	V006-20	V006-55
Motor	2 HP, 2-stage bypass	2 HP, 2-stage bypass
Power Supply	115V, 60 Hz	115V, 60 Hz
Power Cord	50 ft. 16-3 SJT	50 ft. 16-3 SJT
Air Flow	110 CFM	110 CFM
Water Lift	117 inches	117 inches
Tank Capacity	20 Gal.	55 Gal.
Tank	Roto-molded Poly	55 Gallon Steel
Capacity	17 Gallon Wet / 1 Bushel Dry	51 Gallon
dB Rating	78 dB	78 dB
Dimensions	22" x 22" x 34"	35" x 35" x 55"
Weight	62 lbs.	124 lbs.

Subject to Change Without Notice



Washable Cloth
Vacuum Bags
#WDH0001ASSY



55 Gallon Drain Valve
#V006-55VALVE



Transport Frame with
55 Gallon Tank



Optional Front Mount
Squeegee #V006FMS



Portable Vacuum Cleaning



Carry vacuum cleaning power on your shoulders. The top fill design on this lightweight, compact backpack vac will prevent clogging so you can optimize your cleaning time. The 6.5 quart tank capacity extends use time. The ergonomic construction of this 10.5 lb. vacuum makes it ideal for cleaning in small areas.

Power

- 1-Stage NBP motor with thermal protection
- 115V, 50/60 Hz (230V optional)
- Short pigtail power cord. Includes 50 ft. 16-3 power cord with molded plug.

Engineered Design

- Roto-molded polyethylene housing is tough, durable and easy to clean. Lifetime housing warranty.
- Lightweight - 10.5 lbs. machine reduces user fatigue
- Comfortable harness and padded shoulder straps with quick-lock adjustable fasteners
- Exceptional filtration capability. The Harrier captures fine particles and helps improve air quality.
- 8 rubber feet for maximum, diffused air exhaust
- Use the disposable paper filter bags (#HPVA005-3) or washable cloth filter (#HPV-BACK-CLTH-BAG)
- Complete tool kit includes flex hose, telescopic wand, 1-piece curved wand, round dusting brush, two-way flat (for hard and soft floors) floor tool and crevice tool

Safety

- 72 dB quiet operation
- UL Listed



Specifications

Model #	Harrier I
Part #	V001-H1-115
Motor	1 stage, 1120 Watt motor
Power	115V, 50/60 Hz (230V optional)
Power Cord	50 ft. 16-3 SJT power cord w/molded plug
Amp Draw	7.0 Amp
Water Lift	96"
Air Flow	144 cfm
Housing	Roto-Molded Polyethylene
Size	8" x 9" x 21"
Tools	4 tools plus 2 piece curved wand
dB Noise Rating	72 dB
Weight	10.5 lbs. with cord

Subject to Change Without Notice



Powerful 1-Stage Motor



Disposable Paper Vacuum Bags
#HPVA005-3

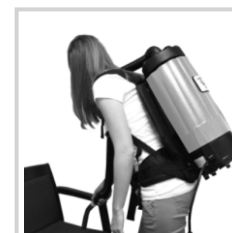

Lightweight Power



Washable Cloth Bags
#HPV-BACK-CLTH BAG



HAWK Propane Burnisher

2000 RPM (21") / 1700 RPM (28") - 18HP

High Speed Burnishing of Hardest Finishes



HPP27

HPP27DC
 with Clutch
 & Dust Control



ELKHART, IN

The Hawk Propane is an ultra-high speed propane burnisher that gives floor care professionals the performance features of higher priced units in one affordable package. Available in two widths and two builds. Rugged, reliable, easy-to-use, and economical.

Power

- Kawasaki 18 HP propane motor with electric start
- Premium fuel regulating system
- Engine is EPA and CARB certified
- California-rated emissions system on Kawasaki engines
- Electric or battery engine start options

Engineered Design

- Heavy duty, American made aluminum deck casting
- Adjustable caster wheels for fine tuning of pad pressure
- Belt drive transmission turns pads at 2000 RPM (21") or 1700 RPM (28") models
- Flexible pad drivers provide excellent pad to floor contact
- Oversize drive bearing
- Handle is ergonomically designed, adjusts easily for operator comfort
- Premium catalytic muffler
- Heavy-duty steel 20 lb. propane tank
- Modular change components
- Available in Dust Collection models
- Available in a Clutch Drive models

Safety Features

- Quiet < 89 dB operation
- UL/CUL listed starter and ignition for safety assurance

Specifications

	HPP21	HPP21DC	HPP27	HPP27DC
Model	HPP21	HPP21DC	HPP27	HPP27DC
Part #	F0028	F0028DC	F0029	F0029DC
Machine Size	21"	21"	28"	28"
With Clutch	No	Yes	No	Yes
With Dust Control	No	Yes	No	Yes
Kawasaki Motor	18 HP	18 HP	18 HP	18 HP
Motor Speed	3600 RPM	3600 RPM	3600 RPM	3600 RPM
Pad Size	21"	21"	28"	28"
Pad Speed	2000 RPM	2000 RPM	1700 RPM	1700 RPM
Drive System	Belt drive	Belt drive	Belt drive	Belt drive
Productivity	25,000	25,000	33,000	33,000
	sq. ft./hour	sq. ft./hour	sq. ft./hour	sq. ft./hour
Machine Size	22.8" x 48"	22.8" x 48"	32.5" x 64.2"	32.5" x 64.2"
Steel Tank	20 lbs.	20 lbs.	20 lbs.	20 lbs.
dB Rating	< 89 dB	< 89 dB	< 89 dB	< 89 dB
Weight	187 lbs.	187 lbs.	200 lbs.	200 lbs.

Subject to Change Without Notice

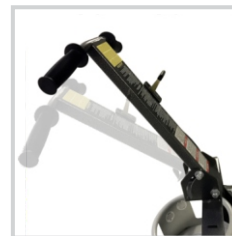

Adjustable Height Ergonomic Handle for Operator Comfort



V-Belt Drives Pads at 2000 RPM



Optional Splash Ring



Optional Active Dust Control Kit



Portable Extraction Cleaning

The Mini-Vector is more than an ordinary spotter. This affordable, powerful, compact unit is designed for superior carpet and upholstery cleaning. The in-line water heater makes cleaning faster.

Power

- 1 HP, 2-Stage vacuum motor
- 115V, 60 Hz
- 13 Amp, 700 W in-line water heater works at 130°F
- 16 ft. 14-3 SJT power cord with molded plug

Engineered Design

- 3.1 gal. solution tank, 3.5 gal. recovery tank
- 45 psi oscillating vacuum pump
- Aluminum lock holds the solution tank to the recovery tank
- 8 ft. vacuum and solution hoses
- Float ball shut-off in the recovery tank protects the vacuum motor from water damage
- Spin-off cover on the lift-off recovery tank makes dumping and rinsing easy
- Switch allows the operator to choose the pre-spray mode with no vacuum, the spray and vacuum mode, and the vacuum only mode
- Includes 4" stainless steel hand wand
- Optional 2-piece, stainless-steel wand with 8 inch head, 10 ft. vacuum hose and solution hose

Safety Features

- Quiet operations - 58 dB. Meets GS42 standard.



ELKHART, IN

Specifications

Model #	3000-Heat
Solution Tank	3.1 Gallons
Recovery Tank	3.5 Gallons
Power Source	115V, 60 Hz. 3-Position Power Switch
Power Cord	16 ft. 14-3 SJT with molded plug
Amp Draw	13 Amp
Heater Power	700 W, 130 degrees F
Water Lift	85 inch
Solution Pump	Oscillating Type, 45 PSI
dB Rating	58 dB - Meets GS42 Standard
Housing	Rotationally Molded Polyethylene
Size	9"W x 18"T x 20"L
Weight	27 lbs. (Machine plus handle and hose)

Subject to Change Without Notice



The Recovery Tank Lifts off the Vacuum Motor Frame



3.5 Gallon Recovery Tank is Easy to Dump and Rinse



Optional Vacuum Wand Set



3.1 Gallon Solution Tank is Easy to Fill



Tight Area Floor Machine Scrubber, Edger

Spotting, Tight Spaces, Baseboards, Stairs



The Talon Edger Floor Machine is designed to scrub built-up dirt in corners and on baseboards without bending and back-breaking effort. Scrub with pads or with optional bonnets or brushes. Includes the pad driver and an assorted pad startup kit.

Power

- 1/8 HP, DC motor
- 115V, 50/60 Hz
- 50 ft. 16-3 SJT detachable power cord

Drive System

- Enclosed, durable gear belt drives brushes and pads at 500 RPM

Engineered Design

- 2 sizes - 6" and 8"
- Handle height adjusts from 47" to 52" with locking pin
- Rotational molded polyethylene housing
- The metal handle collapses over for easy transport and storage
- The brush drive is injection molded, reinforced resin with the unique Mag-Lok™ magnetic system to securely mount brushes and pad drivers without tools
- Optional bristle brushes, pads and bonnets driver

Safety Features

- Built with UL approved components



Red Scrub
6" AS009-CS
8" AS009-8CS



White Polish
6" AS011-CS
8" AS011-8CS

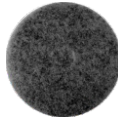

Black Strip
6" AS010-CS
8" AS010-8CS



Pad Driver (1)
6" AS003-6
8" AS003-8



Nylon (1)
6" AS005-6
8" AS005-8



Grit (1)
6" AS006-6
8" AS006-8



Nylon Edger (1)
6" AS002-6
8" AS002-8

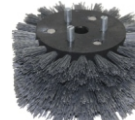

Grit Edger(1)
6" AS001-6
8" AS001-8



Bonnet (6)
6" AS008-6
8" AS008-8



ELKHART, IN



ENGINEERING

Specifications

Model #	Talon-6	Talon-8
Part #	F0036-115-BLK	F0036-116-8BLK
Motor	1/8 HP, DC	1/8 HP, DC
Power	115V, 50/60 Hz	115V, 50/60 Hz
Power Cord	50 ft. 16-3 SJT	50 ft. 16-3 SJT
Brush Size	6"	8"
Brush Speed	500 RPM	500 RPM
Brush Mount	Mag-Lok™	Mag-Lok™
Amp Draw	1.1 Amp	1.1 Amp
Handle	Adjustable 47" to 52" with locking pin	
Housing	Molded high density plastic	
Size	6"x11"x47"	8"x11"x47"
	Adjustable to 52"	Adjustable to 52"

Subject to Change Without Notice



Talon Scrubs in Tight Spaces

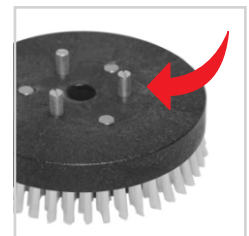

Mag-Lok™ 3 Steel Drive Pins Mount Brushes & Pad Driver



Adjustable Handle Height Locks to Position



Talon Tools Strip, Scrub & Polish



Rotary Floor Machine Accessories



Dust Pickup Systems
for 66 Frame Motors
#HP0031-DC17-STANDKIT
#HP0031-DC20-STANDKIT



Dust Pickup System for
180 Frame TE Motors
Rotary Machine Models
#HP0031-DC17-BRUTEKIT
#HP0031-DC20-BRUTEKIT



Dust Pickup Systems
for All Floating Head
Rotary Design Models
#HP0031-DC17-GLIDE
#HP0031-DC20-GLIDE



Vacuum Assembly Kit
#TH1011



**Vacuum Assembly
Dust Ring, Tank
Vacuum & Hardware**
#TH1011-STD17 - 17"
#TH1011-STD20 - 20"



Splash Guard
#SPLASH13 - 13"
#SPLASH15 - 15"
#SPLASH17 - 17"
#SPLASH20 - 20"



Splash Guard
SPLASH17-WD - 17"
SPLASH20-WD - 20"
For Glide, Merlin
Machines



Hexagonal Weight
for Rotary Motor Mount
#HPA0028-10P - 10 lbs.
#HPA0028-25P - 25 lbs.



**4.5" Weight Post
Mount**
for Hexagonal Weights#
#HP-0008-45STAND
(Use on 66 Frame
Motors)



Weight Post Mount
for Hexagonal Weights
#HP0008-45INCHBRUTE
Use on 180 Frame
TEFC Motors



20# Frame Weight*
#HPA0032-2P
Recommend for 11:1
XHD Gear Models Only



**(1) 25# Horseshoe Wt.
#HPA0032-1P
Mounting Pin Kit
#HP0023**
Best when used with
11:1 XHD Gear Models



Power Lock Kit
Locks the Handle
in the "UP" Position
#HP0005-BLACK



**2.5 Gallon
Solution Tank**
for Mighty
#A001-BLK25 - Black



4 Gallon Solution Tank
5 Stock Colors
4 Special Order Colors
#A0001-4-Color



**4.5 Gallon
Solution Tank**
#SME-0193-INATASSY



Frame Valve
for Solution Tank
#KIT2061



Private Brand Machines
7 Stock Colors
Plus Chrome



HAWK Accessories & Supplies for Rotary Floor Machines

Rotary Brushes, Pads, Pad Drivers & Hardware



Tampico Polishing / Scrubbing Brush
#A0021 - 13"
#A0035 - 15"
#A0004 - 17"
#A0005 - 20"



Stiff Poly Scrub Brush
For general scrubbing
#A0020 - 13"
#A0036 - 15"
#A0002 - 17"
#A0003 - 20"



Lite Grit Brush
Scrub with flexible blue 150 grit bristles
#A0018-1 - 13"
#A0038-1 - 15"
#A0008-1 - 17"
#A0009-1 - 20"



Grit Brush
Strip/scrub with stiff black 80 Grit bristles
#A0018 - 13"
#A0038 - 15"
#A0008 - 17"
#A0009 - 20"



Nylon Carpet Brush
Scrub with soft & stiff nylon bristle mix.
#A0016 - 13"
#A0037 - 15"
#A0006 - 17"
#A0007 - 20"



Hawk Spin Safe Carpet Brush w/Adjustable S/S Glide Plate
Smooth adjustable plate protects the carpet.
#A0013-17 - 17"
#A0013-20 - 20"

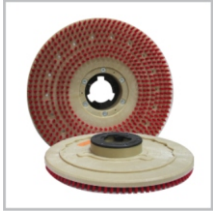

Tufted Stiff Poly Bristle Pad Driver
3/4" long bristles. 3/4" riser.
#1007 - 12"
#A0018-1 W/R - 13"
#A0010-4 - 17"
#A0011-3 - 20"



Premium Double Hook Pad Driver
Molded polymer pad face has hundreds of individual hooks that securely grip and hold pads. Riser and showerfeed block
#A0017 - 13"
#A0034 - 15"
#A0010 - 17"
#A0011 - 20"



Hawk Lok™ Pad Driver
Molded design with universal clutch plate, built-in riser and a triangular showerfeed system handles the toughest jobs.
#0034-4 - 15"
#A0010-5 - 17"
#A0011-4 - 20"

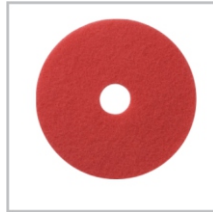

Red Buffing Pad (5 Pack)
Use at 175-600 RPM for everyday cleaning and light scrubbing.
#A0026-13R-CS - 13"
#A0026-15R-CS - 15"
#A0026-17R-CS - 17"
#A0026-20R-CS - 20"

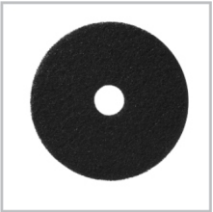

Black Stripping Pad (5 Pack)
Heavy-duty scrubbing and for removal of 2-4 coats of finish/sealer. Washable. Reusable.
#A0026-13BK-CS - 13"
#A0026-15BK-CS - 15"
#A0026-17BK-CS - 17"
#A0026-20BK-CS - 20"



Pad Centering Clamp - 2-Piece
2-piece clamp clips together securely holding any size pad.
#KIT2013 - Screw Lock
#KIT2014 - Spring Lock

*Rotary brush blocks are 2" smaller than machine size. Rotary pad driver blocks are 1" smaller than machine size. All have Universal clutch plate.

Floor Prep Tools



Surface Prep Scraper
(6) replaceable Tungsten Steel Scraping Heads, bolt to steel drive plate. Universal steel clutch plate.
#HP0035 - 13"
N/A - 15"
#HP0033 - 17"
#HP0034 - 20"



Orbitec Diamond Driver
(6) steel mounting cups hold 3" diamond tools. Universal steel clutch plate.
#HP0018 - 13"
N/A - 15"
#HP0017-3 - 17"
#HP0020-3 - 20"



Diamond Pad Driver
#A0017DPD - 13"
N/A - 15"
#A0010DPD - 17"
#A0011DPD - 20"



Weighted Diamond Pad Driver
Steel pad driver block adds up to 64 lbs of pressure. Molded pins securely hold pads for HD floor prep.
#A0017WTDPD - 13" (25#)
#A0010WTDPD - 17" (46#)
#A0011WTDPD - 20" (64#)



Premium Sandpaper Driver
1" thick plywood block 1" riser and universal clutch plate. 1/2" thick cushion and steel mounting disc holds sandpaper
#A0014-HD - 17"
#A0014-1HD - 20"



Hawk Claw Diamond Tool Driver
with steel clutch plate
#CLAW10 - 10"
#CLAW13 - 13"
#CLAW15 - 15"
#CLAW17 - 17"
#CLAW20 - 20"



HAWK Orbital Floor Machine Accessories



Dust Control Kit
 Skirt and Hardware
 HP0031-DC-TIGER2014
 HP0031-DC-TIGER2814



Vacuum Assembly Kit
 6 Quart Tank Vac
 Skirt and Hardware
 #TH1011-RT



Solution Tank
 2.5 Gallon
 #A001-RAPBLK2.5 -
 Black



Solution Tank
 4.5 Gallon
 #SME0193-INATASSY

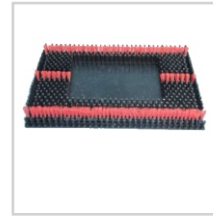

Orbital Scrub Brush
 20" x 14"
 A0076-2014

Orbital Pads and Screens



**Red Orbital
 Scrubbing Pads**
 5 Case



**Black Orbital
 Stripping Pads**
 5 Case

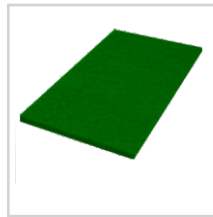

**Green Astro Textured
 Surface Pads**
 4 Case

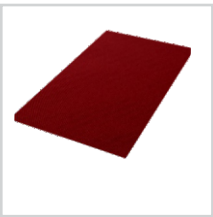

**Hawk Surface Prep
 Pads - Maroon**
 10 Case

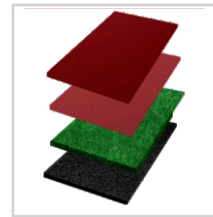

Orbital Pad Starter Kit
 (1) Green, (1) Red
 (2) Black, (2) Maroon



Abrasive Screens
 10 Case

Orbital Pad Color	10" x 14" for TigerHawk 1410	20" x 14" for TigerHawk 2014 G2 Raptor, Red Tail	28"x14" For TigerHawk 2814
Red (5/cs.)	A0066-1410-CS	A0066-2014-CS	A0066-2814-CS
Black (5/cs.)	A0069-1410-CS	A0069-2014-CS	A0069-2814-CS
Green Astro (4/cs.)	A0072-1410-CS	A0072-2014-CS	A0072-2814-CS
Maroon (10/cs.)	A0064-1410-CS	A0064-2014-CS	A0064-2814-CS
Orbital Starter Kit (1 black, 1 green, 1 red, 2 maroon)	A0075-1410PADKIT	A0075-2014PADKIT	A0075-2814PADKIT
Red Heat Screen 80 Grit	A0074-1410-80	A0074-2014-80	A0074-2814-80
Red Heat Screen 120 Grit	A0074-1410-120	A0074-2014-120	A0074-2814-120
Red Heat Screen 180 Grit	A0074-1410-180	A0074-2014-180	A0074-2814-180



High Speed Machine Accessories



Optional Splash Guard
#SPLASH13 - 13"
#SPLASH15 - 15"
#SPLASH17 - 17"



7 Private Brand Colors
 Plus Chrome



Dust Ring and
Dust Filter Kit
 for DC Burnishers
#HPA0029-2KIT



Dust Filter
#A00029-2



Burnishers Include
 Flexible
 Pad Driver with
 Centering Clamp



Hogs Hair Burnishing
Pads
 (5 Pack)
#A0025-13P-CS - 13"
#A0025-15P-CS - 15"
#A0025-16P-CS - 16"
#A0025-17P-CS - 17"
#A0025-19P-CS - 19"



White Polishing Pads
 (5 Pack)
#A0025-13P-W - 13"
#A0025-15P-W - 15"
#A0025-16P-W - 16"
#A0025-17P-W - 17"
#A0025-19P-W - 19"
#A0025-20P-W - 20"



Pad Centering
Clamp - Screw Mount
#KIT2013



Pad Centering
Clamp - Spring
Mount
#KIT2014



Discover Private Branding

You want the strongest, most reliable equipment on the market. Now, we make it easy for you to partner your company's name recognition, reputation and business support with quality products and superior marketing with Private Branded Equipment.

Why Private Branding?

- HAWK Private Branding puts you in control of your product offering, marketing focus and price strategies.
- You build your own *brand recognition*. Custom labels put your company name, brand name, and phone number in front of the user every time.
- Your clients are another step closer to one-stop shopping.

Partner with Hawk

- You can offer the most durable machines on the market with the latest engineering designs like the Glide Floating Head floor machines and the TigerHawk orbital machines.
- Hawk makes your job easier with unmatched service excellence and prompt private brand product delivery. Our professional marketing supports give your sales force a complete selling package.

What are the Other Pieces of the Package?

- **Added-Value Custom Literature** - The "How to Use" guides carry your logo and contact information.
- **Advertising Strength** - We supply your advertising department with product description text and art for your catalogs and website.
- **Instruction Manuals** - Manuals explain start-up, operation, problem solving, and aftermarket brush and pad selections.

How Do We Get Started?

- Fill out our Private Branding Order Form - it identifies all of the product design criteria.
- Our sales rep helps define colors, logo and contact information, photos and text for your website.
- From start to finish, you can have your complete product line in as little as one week!
- To contact your floor machine representative, just call us.





The Private Branding Order Form makes it easy to build the EXACT machine that you want.

- Select the machine model, working size, power voltage and motor type and size.
- Customize the model with factory-installed accessories like special dust control assemblies, weights, splash guards and aftermarket accessories.
- Power Cords - select the power cord strength, color (yellow, black or gray), and length (50, or 75 ft.).
- Motor and Handle Labels - Hawk sends you label specifications for your design and production, or we can design with your colors, logo and contact information.
- Colors - Select from 7 standard colors or chromed brush covers.
- Special colors and design are available with set minimum quantities.

The Hawk Private Brand System combinations produce hundreds of products. Our sales reps can help you fill out the form for the exact results you demand.

HAWK ENTERPRISES PRIVATE BRANDING ORDER FORM

DATE REC'D **REC'D BY** **OFFICE USE ONLY**
 Click here to enter date. **CUSTOMER ID** **PART NUMBER** **B.O.M. BUILT**
COMMENTS:

WARNING THIS DOCUMENT CONTAINS CONFIDENTIAL INFORMATION
****IMPORTANT NOTICE****
 Please complete this document in its entirety with the most accurate information possible. This will ensure there are no miscommunications between our customers and Hawk Enterprises. Partial forms WILL NOT be accepted for review. **Your company representative must sign in the provided locations throughout this document for it to be considered valid!**

CUSTOMER INFORMATION
COMPANY NAME:
ADDRESS:
SUITE: **P.O. BOX:**
CITY: **STATE:** **ZIP CODE:**
PHONE:

COMPANY CONTACT INFORMATION
FIRST: **LAST:**
PHONE: **EXTENSION:**
EMAIL: **FAX:**

STANDARD FLOOR MACHINE

STEP 1: MACHINE SIZE
 10 INCH 13 INCH 15 INCH 17 INCH 20 INCH

STEP 2: MOTOR OPTIONS

HORSEPOWER	VOLTAGE	FREQUENCY	GEARBOX	COLOR
1.0HP <input type="checkbox"/>	115v <input type="checkbox"/>	60hz <input type="checkbox"/>	STANDARD <input type="checkbox"/>	CHROME <input type="checkbox"/>
1.5HP <input type="checkbox"/>	230v <input type="checkbox"/>	50hz <input type="checkbox"/>	XTRA HEAVY DUTY <input type="checkbox"/>	BLACK <input type="checkbox"/>

**1.0HP MOTORS ARE ONLY AVAILABLE IN CHROME*

STEP 3: SPECIAL MACHINE OPTIONS
 PROSERIES CE

***PROSERIES AUTOMATICALLY SELECTS:**
 -LONG CONNECTING LEGS -UPPER CAM LOCK -SOLUTION TANK -SPLASH GUARD -PAD DRIVERS

STEP 4: FRAME COLOR SELECTION
 BLACK HAMMERSILVER RED

STEP 5: BRUSH COVER OPTIONS

COLOR	BUMPER COLOR	SPECIAL OPTIONS
RED <input type="checkbox"/>	BLACK <input type="checkbox"/>	INTERCHANGEABLE <input type="checkbox"/>
MOODY BLUE <input type="checkbox"/>	GRAY <input type="checkbox"/>	
ORANGE <input type="checkbox"/>	RED <input type="checkbox"/>	
ROYAL BLUE <input type="checkbox"/>	YELLOW <input type="checkbox"/>	
CHROME <input type="checkbox"/>	TEAL <input type="checkbox"/>	
GREEN <input type="checkbox"/>	HAMMERSILVER <input type="checkbox"/>	
YELLOW <input type="checkbox"/>		

***SOME COLORS MAY REQUIRE MINIMUM QUANTITY ORDER*

12-3 ONLY YELLOW 75FT. 100FT. **NOSTYLE OPTIONS**
 14-3 GRAY BLACK 50FT. 75FT. 1pc
 YELLOW 100FT. 2pc

STEP 10: SWITCHBOX COVER OPTIONS

STYLE	COLOR
ANGLE <input type="checkbox"/>	RED <input type="checkbox"/>
SQUARE <input type="checkbox"/>	CHROME <input type="checkbox"/>
ROUND <input type="checkbox"/>	BLACK <input type="checkbox"/>
CE <input type="checkbox"/>	ROYAL BLUE <input type="checkbox"/>
	MOODY BLUE <input type="checkbox"/>
	ORANGE <input type="checkbox"/>
	TEAL <input type="checkbox"/>
	YELLOW <input type="checkbox"/>
	HAMMERSILVER <input type="checkbox"/>

LABELING OPTIONS
 NO YES IF YES PLEASE SPECIFY:
WARNING LABEL LANGUAGE
 ENGLISH SPANISH

STEP 11: ACCESSORIES

SOLUTION TANK
 NO YES NATURAL BLACK ROYAL BLUE MOODY BLUE
 RED CHARCOAL YELLOW

WEIGHTS
 FRAME WEIGHT (20LBS) ****A** NO YES
 HORSESHOE WEIGHTS ****A** 25LB 36LB
**NOTICE: YOU CANNOT COMBINE FRAME WEIGHTS WITH HORSE SHOE WEIGHTS*
***ONLY VALUABLE ON 17 INCH AND 20 INCH MACHINES*

EXTRA WEIGHTS
 10LB 25LB
**NOTICE: ADDING WEIGHTS TO YOUR MACHINE AUTOMATICALLY ADD THE WEIGHT IN PINK*

OTHER ACCESSORIES
SPLASH GUARD NO NO LIP
 WITH LIP (FOR WEIGHTED MACHINES)
DUST CONTAINMENT SYSTEM NO YES

HAWK ENTERPRISES

**Rotary Floor Machines • Orbital Floor Machines • High Speed Burnishers
Air Movers • Vacuums • Specialty Cleaning Equipment • Parts & Supplies**



HAWK ENTERPRISES 2902 Park Six Court, Elkhart, IN 46514

(574) 294-1910

www.hawkenterprises.com